

www.routmac.com

Heavy Duty Helical Planer Cutter Heads

AM814

AM814 Heavy Duty Helical Planer Cutter Heads



Accessories	Size(mm)
	14 X 14 X 2
	13 X 12 X 11
	M8 X 20
 Screwdriver	4 X 100

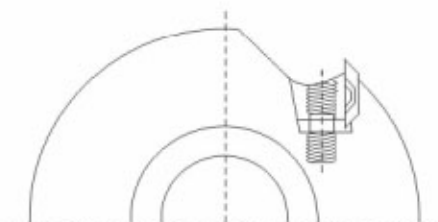

- Cutter head body: aluminum alloy / light alloy
- Suitable for Four side moulders, copy shapers, spindle shapers.
- Suitable materials : solid wood, plywood, acryl, MDF
- For soft wood use L14*14*2*37 degrees
- For hard wood use L14*14*2*30 degrees

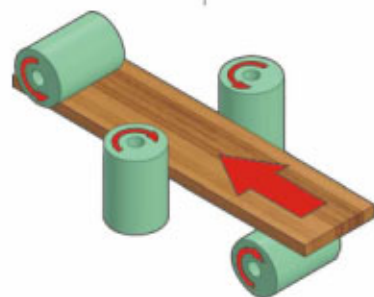

Heavy Duty Helical Planer Cutter Heads

ϕ D mm	L mm	ϕ d mm	Z	knives pcs
100	60	30/31.75/32/35/40	6	12
100	80	30/31.75/32/35/40	6	16
100	100	30/31.75/32/35/40	6	22
100	130	30/31.75/32/35/40	6	28
100	150	30/31.75/32/35/40	6	32
100	160	30/31.75/32/35/40	6	34
100	180	30/31.75/32/35/40	6	38
100	203	30/31.75/32/35/40	6	44
125	60	40/46.0375/50	6	12
125	80	40/46.0375/50	6	16
125	100	40/46.0375/50	6	22
125	130	40/46.0375/50	6	28
125	150	40/46.0375/50	6	32
125	160	40/46.0375/50	6	34
125	180	40/46.0375/50	6	38
125	203	40/46.0375/50	6	44
125	230	40/46.0375/50	6	50

Heavy Duty Helical Planer Cutter Heads

AM1030



Accessories	Size(mm)
	30 X 12 X 1.5
	28 X 15 X 9.5
	M10 X 20
	5 X 150

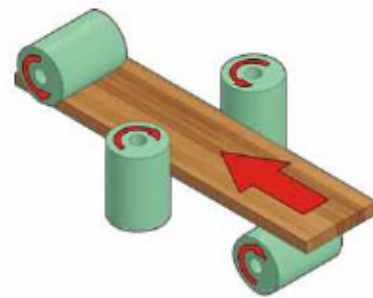



- Cutter head body: aluminum alloy / light alloy
- Suitable for Four side moulders
- Suitable materials : solid wood, plywood, acryl, MDF
- Knife:L30*12*1.5*35 degrees

Heavy Duty Helical Planer Cutter Heads				
ϕ D mm	L mm	ϕ d mm	Z	knives pcs
100	60	30/31.75/32/35/40	6	6
100	80	30/31.75/32/35/40	6	8
100	100	30/31.75/32/35/40	6	12
100	130	30/31.75/32/35/40	6	16
100	160	30/31.75/32/35/40	6	20
100	180	30/31.75/32/35/40	6	22
100	203	30/31.75/32/35/40	6	26
125	60	40/46.0375/50	6	6
125	80	40/46.0375/50	6	8
125	100	40/46.0375/50	6	12
125	130	40/46.0375/50	6	16
125	160	40/46.0375/50	6	20
125	180	40/46.0375/50	6	22
125	203	40/46.0375/50	6	26
125	230	40/46.0375/50	6	30

Helical Planer Cutter Heads

AM615



Accessories	Size(mm)
	15 X 15 X 2.5
	M6 X 15
 Screwdriver	4.5 X 100

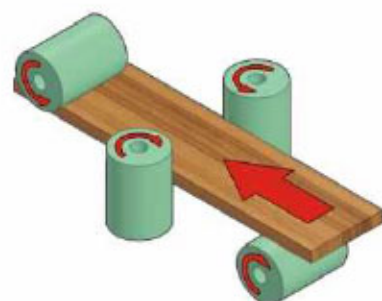





- Cutter head body: aluminum alloy / light alloy
- Suitable for Four side moulders, copy shapers, spindle shapers.
- Suitable materials : solid wood, plywood, acryl, MDF
- Knife: L15*15*2.5*30 degrees

Helical Planer Cutter Heads				
ϕ D mm	L mm	ϕ d mm	Z	knives pcs
100	60	30/31.75/32/35/40	6	15
100	80	30/31.75/32/35/40	6	18
100	100	30/31.75/32/35/40	6	24
100	130	30/31.75/32/35/40	6	30
100	153	30/31.75/32/35/40	6	36
100	160	30/31.75/32/35/40	6	39
100	180	30/31.75/32/35/40	6	48
100	203	30/31.75/32/35/40	6	48
125	60	40/46.0375/50	6	15
125	80	40/46.0375/50	6	18
125	100	40/46.0375/50	6	24
125	130	40/46.0375/50	6	30
125	153	40/46.0375/50	6	36
125	180	40/46.0375/50	6	48
125	203	40/46.0375/50	6	48
125	230	40/46.0375/50	6	60

Helical Planer Cutter Heads

SM615



Accessories	Size(mm)
	15 X 15 X 2.5
 	M6 X 15
	4.5 X 100

- Cutter head body: steel
- Suitable for Four side moulders, copy shapers, spindle shapers.
- Suitable materials : solid wood, plywood, acryl, MDF
- Knife: L15*15*2.5*30 degrees

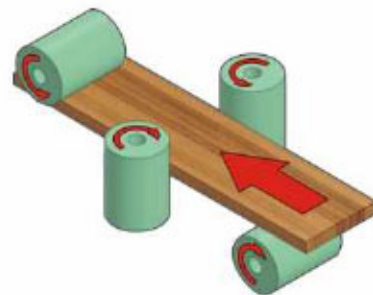

Helical Planer Cutter Heads

ϕ D mm	L mm	ϕ d mm	Z	knives pcs
100	60	30/31.75/32/35/40	6	15
100	80	30/31.75/32/35/40	6	18
100	100	30/31.75/32/35/40	6	24
100	130	30/31.75/32/35/40	6	30
100	153	30/31.75/32/35/40	6	36
100	160	30/31.75/32/35/40	6	39
100	180	30/31.75/32/35/40	6	48
100	203	30/31.75/32/35/40	6	48
125	60	40/46.0375/50	6	15
125	80	40/46.0375/50	6	18
125	100	40/46.0375/50	6	24
125	130	40/46.0375/50	6	30
125	153	40/46.0375/50	6	36
125	180	40/46.0375/50	6	48
125	203	40/46.0375/50	6	48
125	230	40/46.0375/50	6	60

Rebbiting Cutter Heads

AM10V4

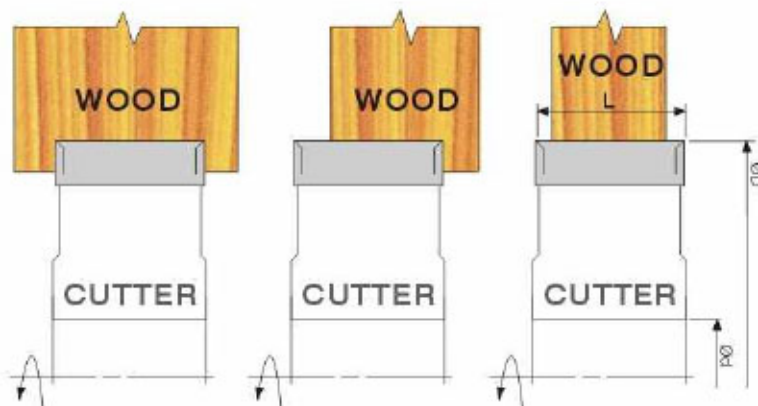

- Cutter head body: aluminum alloy / light alloy
- Suitable for Four side moulders, copy shapers, spindle shapers.
- Suitable materials : solid wood, plywood, acryl, MDF
- With spur (scoring knives)

Accessories	Size(mm)
 Knife	30 X 12 X 1.5 X 35° 50 X 12 X 1.5 X 35° 60 X 12 X 1.5 X 35°
 Spur	14 X 14 X 2 X 30°
 Wedge	28 X 16 X 9.5 48 X 16 X 9.5 58 X 16 X 9.5
 Screw	M10 X 20 M10 X 25
 Screw	M6 X 10 M6 X 15
 Screwdriver	5 X 150
 Screwdriver	4.5 X 100

Rebbiting Cutter Heads

ϕ D mm	L mm	ϕ d mm	Z	V
100	30	30/31.75/32/35/40	4	4
100	50	30/31.75/32/35/40	4	4
100	60	30/31.75/32/35/40	4	4
125	30	30/31.75/32/35/40/46.0375/50	4	4
125	50	30/31.75/32/35/40/46.0375/50	4	4
125	60	30/31.75/32/35/40/46.0375/50	4	4

Corrugated Back Cutter Heads

SM1070



Accessories	Size(mm)
 Knife	L X 50-70 X 8
 Wedge	L X 24 X 12
 Screw	M10 X 25
 Screwdriver	5 X 150

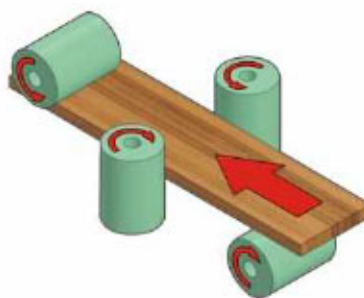
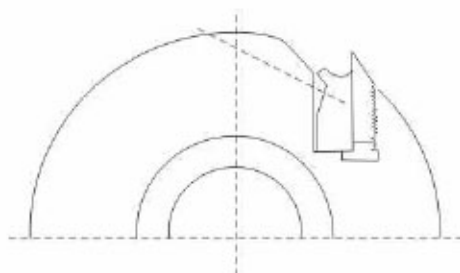

- Knife:T8*W50/60/70*Length..
- Suitable for Four side moulders.

Corrugated Back Cutter Heads				
ϕ D mm	L mm	ϕ d mm	Z	
122	50	40/46.0375/50	4	
122	60	40/46.0375/50	4	
122	80	40/46.0375/50	4	
122	100	40/46.0375/50	4	
122	130	40/46.0375/50	4	
122	153	40/46.0375/50	4	
122	180	40/46.0375/50	4	
122	203	40/46.0375/50	4	
122	230	40/46.0375/50	4	

Planer / Moulder Cutter Heads

AM1230



Accessories	Size(mm)
 Knife	L X 30 X 3
 Wedge	L X 24 X 12
 Screwdriver	5 X 150 6 X 150
 Screw	M10 X 25 M12 X 30
 Spring	

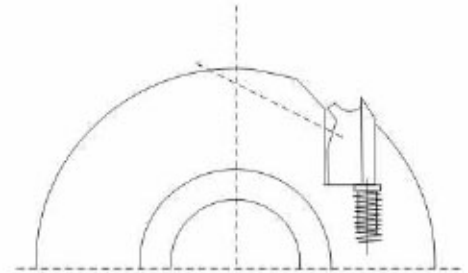

- Cutter head body: aluminum alloy / light alloy.
- Suitable for Three side moulders, Four side moulders and spindle shapers.
- Replacement knives : L*W30mm*T3mm / HSS or carbide tipped.

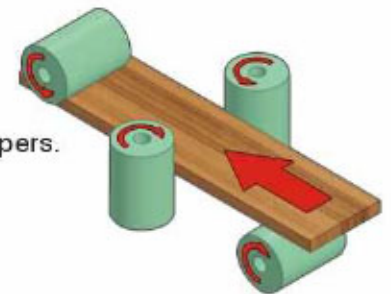

Planer / Moulder Cutter Heads

ϕ D mm	L mm	ϕ d mm	Z
100	60	30/31.75/32/35	4
100	80	30/31.75/32/35	4
100	100	30/31.75/32/35	4
100	130	30/31.75/32/35	4
125	80	40/46.0375/50	4
125	100	40/46.0375/50	4
125	130	40/46.0375/50	4
125	153	40/46.0375/50	4
125	180	40/46.0375/50	4
125	203	40/46.0375/50	4
125	230	40/46.0375/50	4

Planer / Moulder Cutter Heads SM1230



Accessories	Size(mm)
 Knife	L X 30 X 3
 Wedge	LX 24 X 12
 Screwdriver	6 X 150
 Screw	M12 X 30
 Spring	

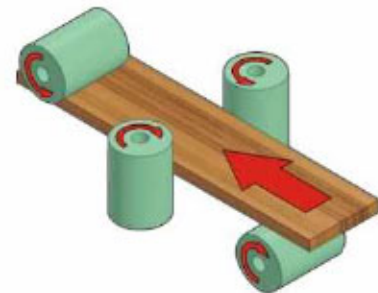
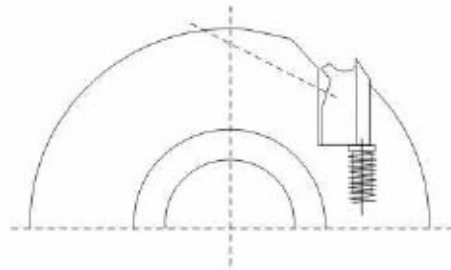

- Cutter head body: Steel.
- Suitable for Three side moulders, Four side moulders and spindle shapers.
- Replacement knives : L*W30mm*T3mm / HSS or carbide tipped.

Planer / Moulder Cutter Heads			
ϕ D mm	L mm	ϕ d mm	Z
125	50	40/46.0375/50	4
125	60	40/46.0375/50	4
125	80	40/46.0375/50	4
125	100	40/46.0375/50	4
125	130	40/46.0375/50	4
125	153	40/46.0375/50	4
125	180	40/46.0375/50	4
125	203	40/46.0375/50	4
125	230	40/46.0375/50	4

SM10100635

Helical Planer Cutter Heads For Single/Double Surface Planers

SM10100635



Helical Planer Cutter		
ϕ D mm	L mm	Z
100-150	300-635	6/8

- Customers' request on the size of the axis on both ends are applicable.
- Suitable for Single side planers, Double side planers.
- Custom designs available.

Accessories	Size(mm)
 knife	30 X 12 X 1.5 30 X 12 X 2.5
 wedge	28 X 15 X 9.5
 screw	M10 X 20
 screwdriver	5 X 150

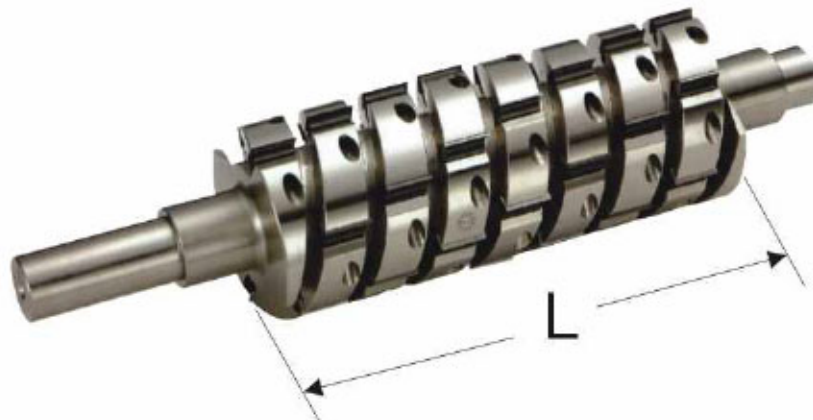

SM675635

Helical Planer Cutter Heads For Single/Double Surface Planers

SM675635

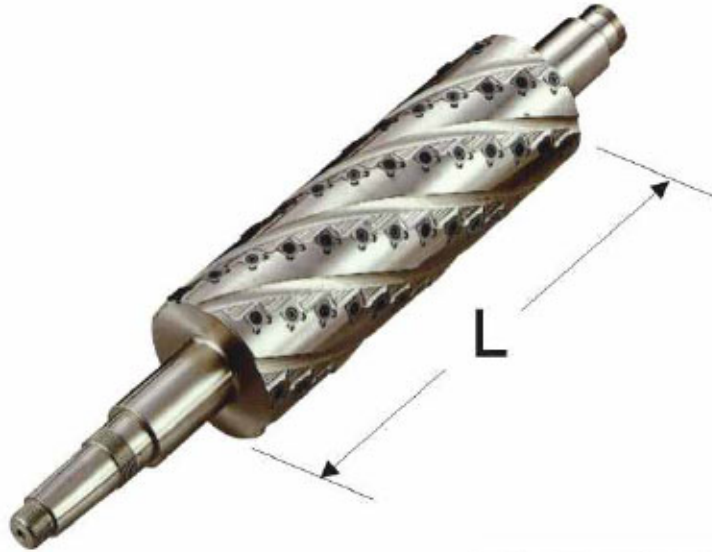

- Customers' request on the size of the axis on both ends are applicable.
- Suitable for Single side planers, Double side planers.
- Custom designs available.

Accessories	Size(mm)
 knife	14 X 14 X 2.0 X 30° 15 X 15 X 2.5X 30° 15 X 15 X 2.5X 37° 14.6 X 14.6 X 2.5X 30°
 screw	M6 X 15
 screwdriver	4.5 X 100
	M615RH12
	M615T2030
	M615T2050

Helical Planer Cutters

ϕ D mm	L mm	Z
75-150	300-635	4/6/8

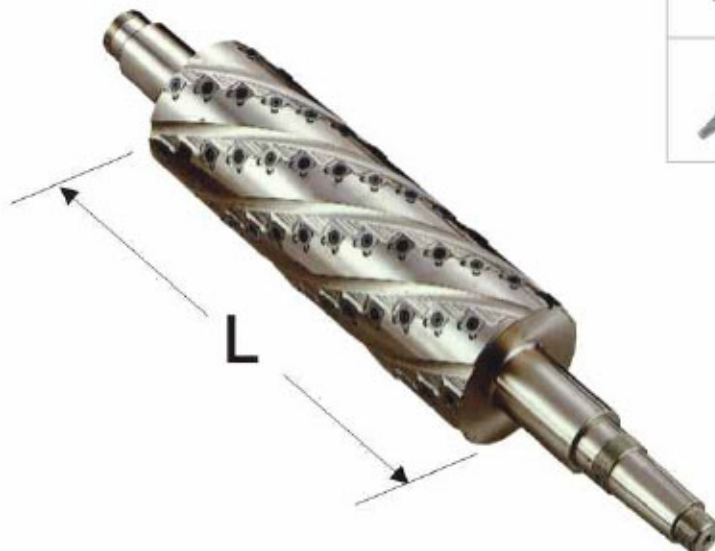

Carbide-Tipped Helical Planer Cutter Heads

W1225

(Brazed T.C.T thickness 4mm)

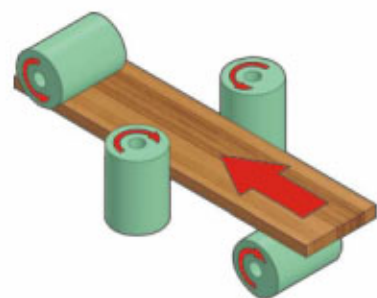

- Suitable for heavy cutting with low noise.
- Special specifications is available as per custom's order.

Carbide-Tipped Helical Planer Cutter Heads

ϕD mm	L mm	ϕd mm	Z
125	50	40/45/46.0375/50	6
125	60	40/45/46.0375/50	6
125	80	40/45/46.0375/50	6
125	100	40/45/46.0375/50	6
125	130	40/45/46.0375/50	6
125	153	40/45/46.0375/50	6
125	180	40/45/46.0375/50	6
125	203	40/45/46.0375/50	6
125	230	40/45/46.0375/50	6
125	250	40/45/46.0375/50	6
125	300	40/45/46.0375/50	6
125	320	40/45/46.0375/50	6

Carbide-Tipped Helical Planer Cutter Heads

W1018

(Brazed T.C.T thickness 5.4mm)

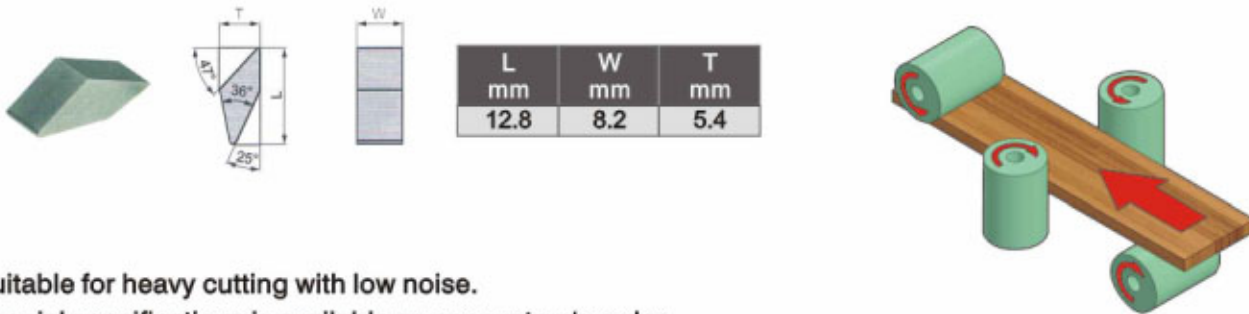

- Suitable for heavy cutting with low noise.
- Special specifications is available as per custom's order.

Carbide-Tipped Helical Planer Cutter Heads

ϕ D mm	L mm	ϕ d mm	Z
100	50	25.4/30/31.75/32/35/40	6/8
100	60	25.4/30/31.75/32/35/40	6/8
100	80	25.4/30/31.75/32/35/40	6/8
100	100	25.4/30/31.75/32/35/40	6/8
100	130	25.4/30/31.75/32/35/40	6/8
100	153	25.4/30/31.75/32/35/40	6/8
100	180	25.4/30/31.75/32/35/40	6/8
125	50	40/45/46.0375/50	6/8
125	60	40/45/46.0375/50	6/8
125	80	40/45/46.0375/50	6/8
125	100	40/45/46.0375/50	6/8
125	130	40/45/46.0375/50	6/8
125	153	40/45/46.0375/50	6/8
125	180	40/45/46.0375/50	6/8
125	203	40/45/46.0375/50	6/8
125	230	40/45/46.0375/50	6/8

Carbide-Tipped Helical Planer Cutter Heads

W1218

(Brazed T.C.T thickness 5.4mm)



L mm	W mm	T mm
12.8	6.2	5.4

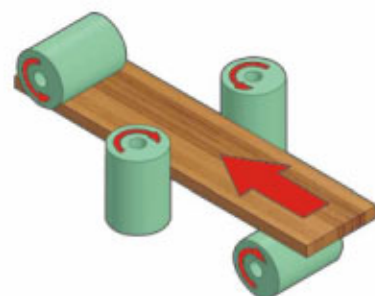

- Suitable for heavy cutting with low noise.
- Special specifications is available as per custom's order.

Carbide-Tipped Helical Planer Cutter Heads

ϕ D mm	L mm	ϕ d mm	Z
100	50	25.4/30/31.75/32/35/40	8/10/12
100	60	25.4/30/31.75/32/35/40	8/10/12
100	80	25.4/30/31.75/32/35/40	8/10/12
100	100	25.4/30/31.75/32/35/40	8/10/12
100	130	25.4/30/31.75/32/35/40	8/10/12
100	153	25.4/30/31.75/32/35/40	8/10/12
100	180	25.4/30/31.75/32/35/40	8/10/12
125	50	40/45/46.0375/50	8/10/12
125	60	40/45/46.0375/50	8/10/12
125	80	40/45/46.0375/50	8/10/12
125	100	40/45/46.0375/50	8/10/12
125	130	40/45/46.0375/50	8/10/12
125	153	40/45/46.0375/50	8/10/12
125	180	40/45/46.0375/50	8/10/12
125	203	40/45/46.0375/50	8/10/12
125	230	40/45/46.0375/50	8/10/12

Carbide-Tipped Helical Planer Cutter Heads

W1218T16

(Braze T.C.T thickness 5.4mm)

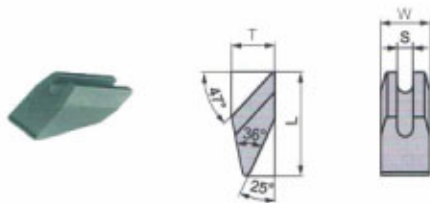
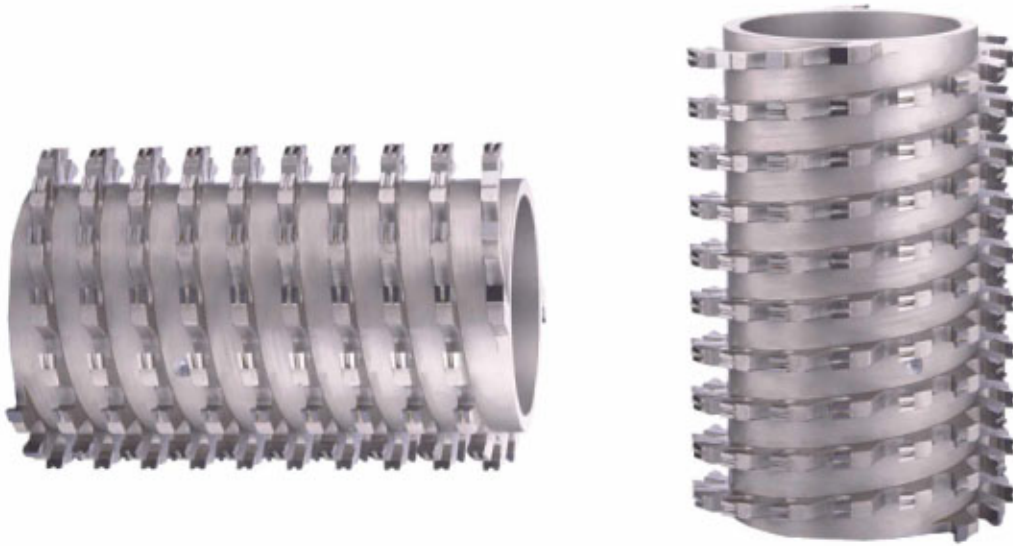

L mm	W mm	T mm	S mm
12.8	6.2	5.4	2.0

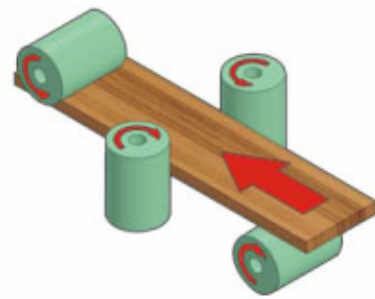

- Suitable for heavy cutting with low noise.
- Special specifications is available as per custom's order.

Carbide-Tipped Helical Planer Cutter Heads			
ϕ D mm	L mm	ϕ d mm	Z
125	50	40/45/46.0375/50	16
125	60	40/45/46.0375/50	16
125	80	40/45/46.0375/50	16
125	100	40/45/46.0375/50	16
125	130	40/45/46.0375/50	16
125	153	40/45/46.0375/50	16
125	180	40/45/46.0375/50	16
125	203	40/45/46.0375/50	16
125	230	40/45/46.0375/50	16

TF501 Carbide-Tipped Planer Cutter Heads

(Brazed T.C.T thickness 4mm)

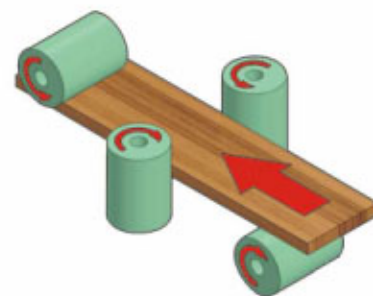
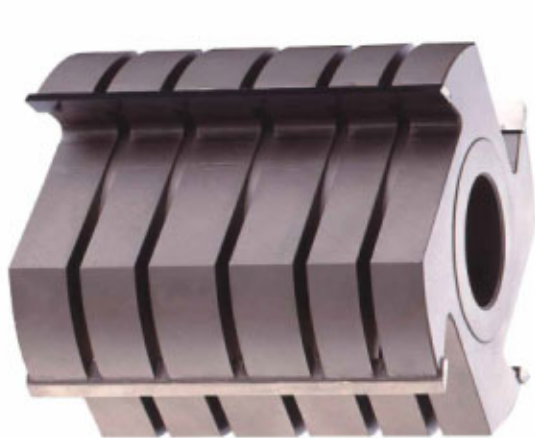

• Special specifications is available as per custom's order.

Carbide-Tipped Planer Cutter Heads

ϕ D mm	L mm	ϕ d mm	Z
100	50	25.4/30/31.75/32/35/40	4
100	60	25.4/30/31.75/32/35/40	4
100	80	25.4/30/31.75/32/35/40	4
100	100	25.4/30/31.75/32/35/40	4
100	130	25.4/30/31.75/32/35/40	4
100	153	25.4/30/31.75/32/35/40	4
100	180	25.4/30/31.75/32/35/40	4
125	50	40/45/46.0375/50	4
125	60	40/45/46.0375/50	4
125	80	40/45/46.0375/50	4
125	100	40/45/46.0375/50	4
125	130	40/45/46.0375/50	4
125	153	40/45/46.0375/50	4
125	180	40/45/46.0375/50	4
125	203	40/45/46.0375/50	4
125	230	40/45/46.0375/50	4
150 Trimming Cutter	11	40/45/46.0375/50	4

TF501AB Carbide-Tipped Planer Cutter Heads with alternating shear

(Braze T.C.T thickness 4mm)

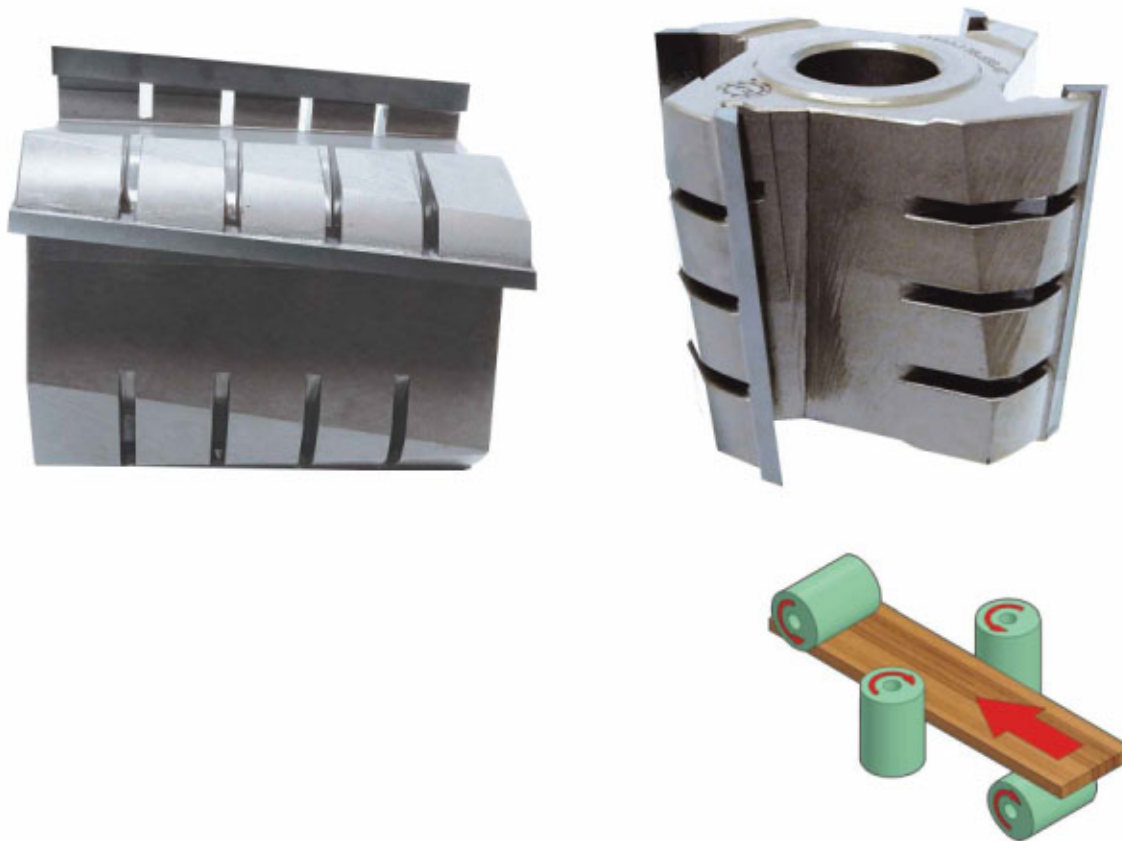

• Special specifications is available as per custom's order.

Planer Cutter Heads-with alternating shear				
ϕD mm	L mm	ϕd mm	Z	
100	50	25.4/30/31.75/32/35/40	4/6	
100	60	25.4/30/31.75/32/35/40	4/6	
100	80	25.4/30/31.75/32/35/40	4/6	
100	100	25.4/30/31.75/32/35/40	4/6	
100	130	25.4/30/31.75/32/35/40	4/6	
100	153	25.4/30/31.75/32/35/40	4/6	
125	50	40/45/46.0375/50	4/6	
125	60	40/45/46.0375/50	4/6	
125	80	40/45/46.0375/50	4/6	
125	100	40/45/46.0375/50	4/6	
125	130	40/45/46.0375/50	4/6	
125	153	40/45/46.0375/50	4/6	

TF502 Wooden Round Rod Cutters

- Brazed T.C.T thickness=4mm
- Suitable for Four side moulders. Round rod milling machines.
- Special specifications is available as per customs' order.

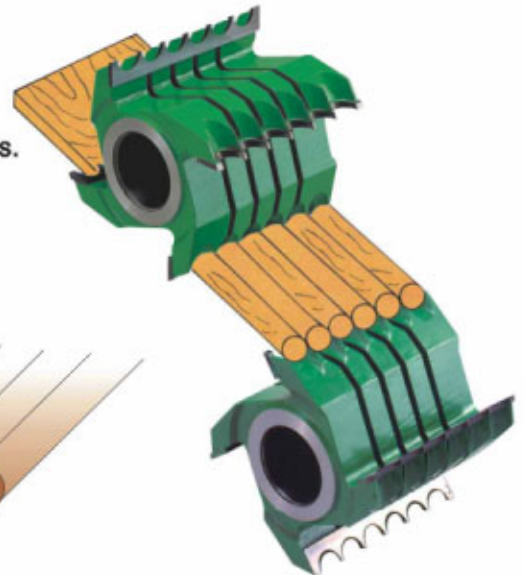
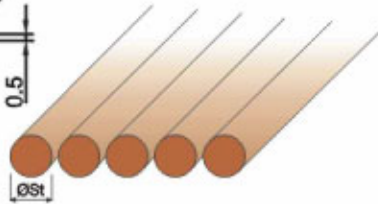
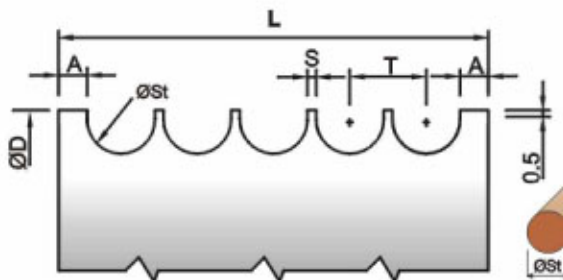

Wooden Round Rod Cutters

ϕ st mm	ϕ D mm	L	ϕ d mm	S	T	A	Z
4	110/130	75mm-150mm	30/40	1	5	6	4
5	110/130	75mm-150mm	30/40	1	6	6	4
6	110/130	75mm-150mm	30/40	1.5	7.5	6	4
7	110/130	75mm-150mm	30/40	1.5	8.5	6	4
8	110/130	75mm-150mm	30/40	1.5	9.5	6	4
9	110/130	75mm-150mm	30/40	1.5	10.5	6	4
10	110/130	75mm-150mm	30/40	1.5	11.5	6	4
11	110/130	75mm-150mm	30/40	1.5	12.5	6	4
12	110/130	75mm-150mm	30/40	1.5	13.5	6	4
13	110/130	75mm-150mm	30/40	1.5	14.5	6	4
14	110/130	75mm-150mm	30/40	1.5	15.5	6	4
15	110/140	75mm-150mm	30/40	1.5	16.5	6	4
16	110/140	75mm-150mm	30/40	2	18	6	4
17	110/140	75mm-150mm	30/40	2	19	6	4
18	110/140	75mm-150mm	30/40	2	20	6	4
19	110/140	75mm-150mm	30/40	2	21	6	4
20	110/140	75mm-150mm	30/40	2	22	6	4
21	110/140	75mm-150mm	30/40	2	23	6	4
22	110/140	75mm-150mm	30/40	2.5	24.5	6	4
23	120/150	75mm-150mm	30/40	2.5	25.5	6	4
24	120/150	75mm-150mm	30/40	2.5	26.5	6	4
25	120/150	75mm-150mm	30/40	2.5	27.5	6	4
26	120/150	75mm-150mm	30/40	2.5	28.5	6	4
27	120/150	75mm-150mm	30/40	2.5	29.5	6	4
28	120/150	75mm-150mm	30/40	2.5	30.5	6	4
29	120/150	75mm-150mm	30/40	2.5	31.5	6	4
30	120/150	75mm-150mm	30/40	3	33	6	4

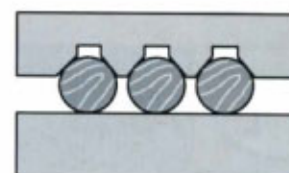
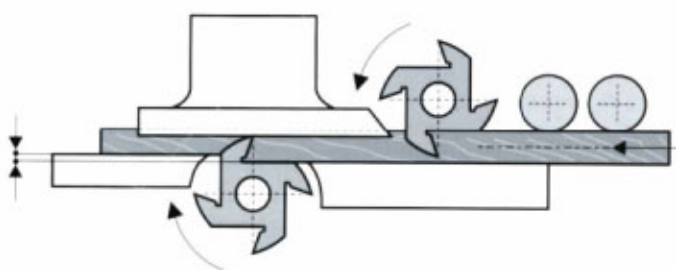

TF503

Wooden Dowel Milling Cutters

- Brazed T.C.T thickness 4mm
- Suitable for Four side moulders. Round rod milling machines.
- Special specifications is available as per customs' order.

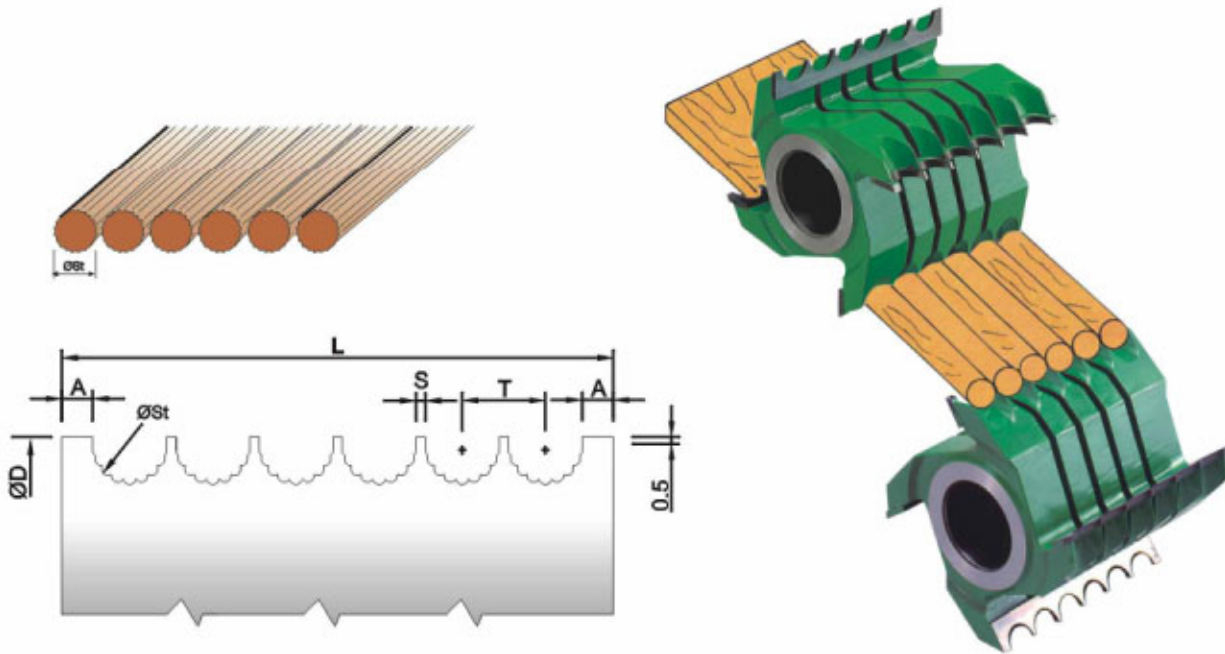

Wooden Dowel Milling Cutters

ϕst mm	ϕD mm	L	ϕd mm	S	T	A	Z
6	110/130	75mm-150mm	30/40	1.5	7.5	6	4
7	110/130	75mm-150mm	30/40	1.5	8.5	6	4
8	110/130	75mm-150mm	30/40	1.5	9.5	6	4
9	110/130	75mm-150mm	30/40	1.5	10.5	6	4
10	110/130	75mm-150mm	30/40	1.5	11.5	6	4
11	110/130	75mm-150mm	30/40	1.5	12.5	6	4
12	110/130	75mm-150mm	30/40	1.5	13.5	6	4
13	110/130	75mm-150mm	30/40	1.5	14.5	6	4
14	110/130	75mm-150mm	30/40	1.5	15.5	6	4
15	110/140	75mm-150mm	30/40	1.5	16.5	6	4
16	110/140	75mm-150mm	30/40	2	18	6	4

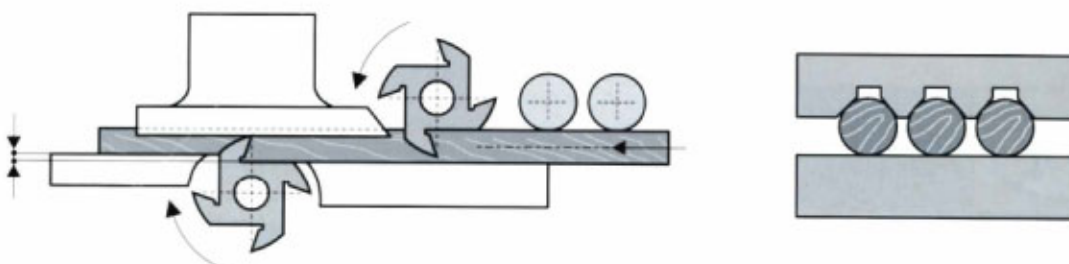

Carbide-Tipped Adjustable Tongue & Groove Flooring Cutter Sets

(Brazed T.C.T thickness 4mm)



TF601A D125*W12~25*d40*Z4/Z6 1SET/4PCS

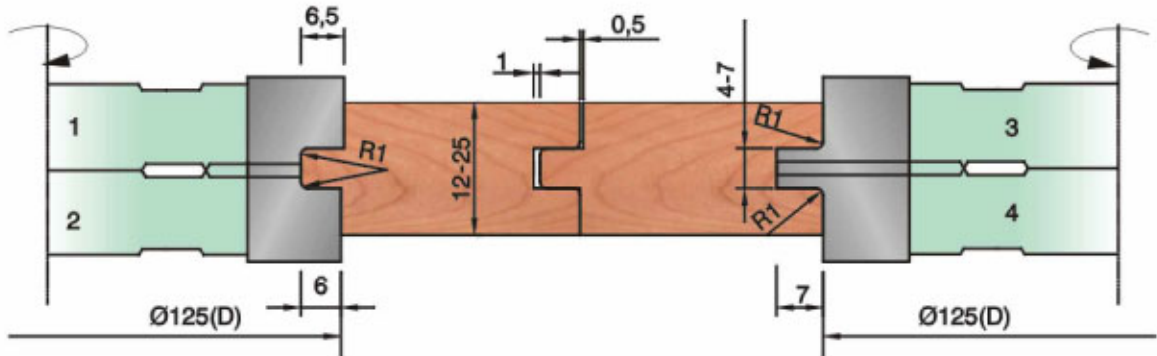

TF601B D125*W15~25*d40*Z4/Z6 1SET/4PCS

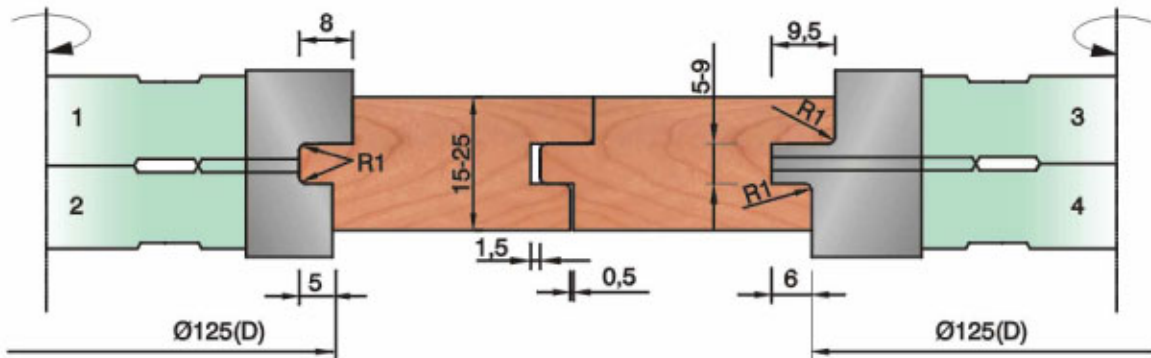

TF601C D125*W10~20*d40*Z4/Z6 1SET/4PCS

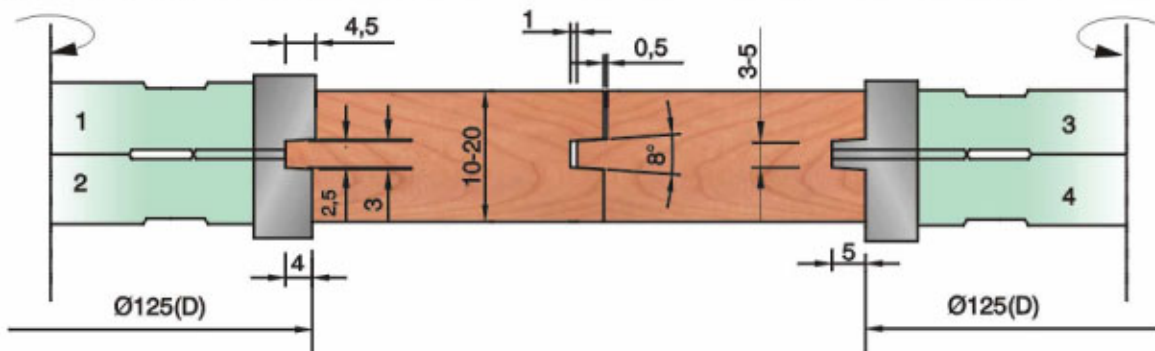

Carbide-Tipped Adjustable Tongue & Groove Flooring Cutter Sets

(Brazed T.C.T thickness 4mm)



TF601D D125*W15~25*d40*Z4/Z6 1SET/6PCS

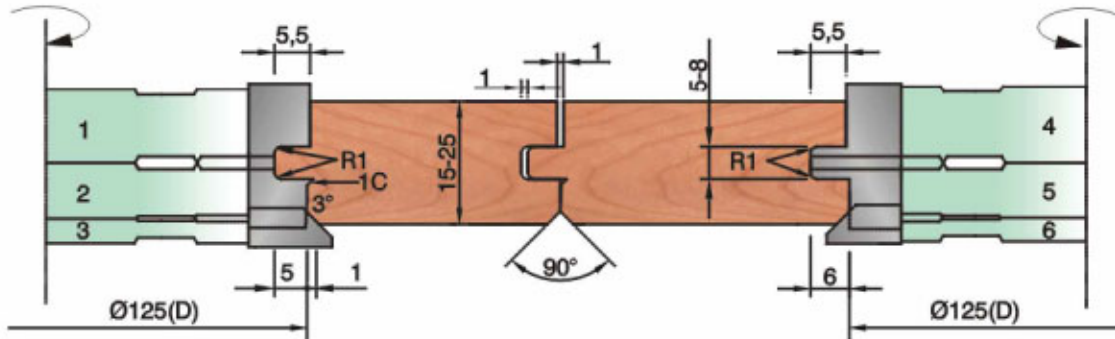

TF601E D125*W12~25*d40*Z4/Z6 1SET/6PCS

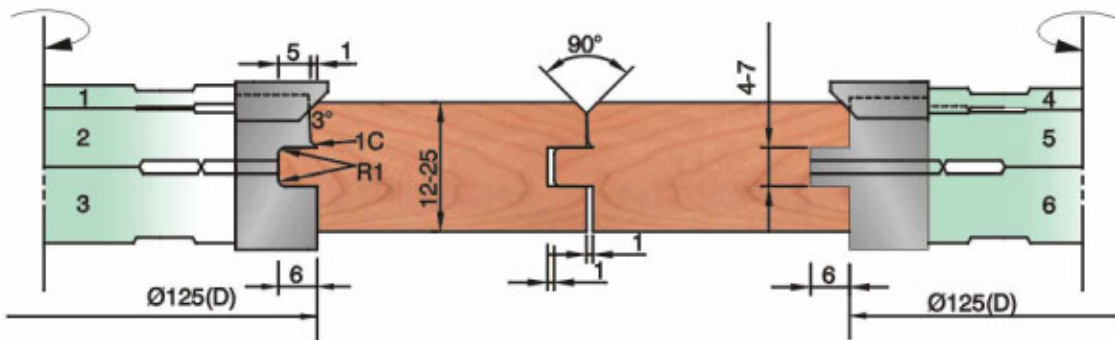

TF601F D125*W10~20*d40*Z4/Z6 1SET/6PCS

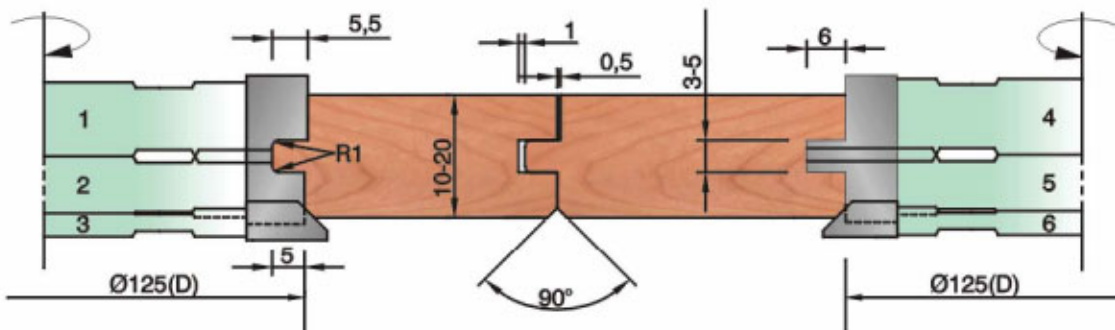

Carbide-Tipped Adjustable Tongue & Groove Flooring Cutter Sets

(Brazed T.C.T thickness 4mm)



TF601G D125*W12~25*d40*Z4/Z6 1SET/6PCS

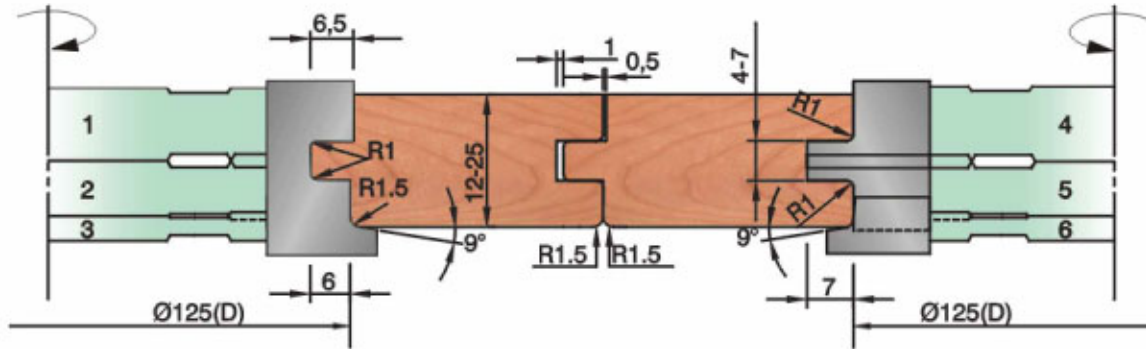

TF601H D125*W12~25*d40*Z4/Z6 1SET/6PCS

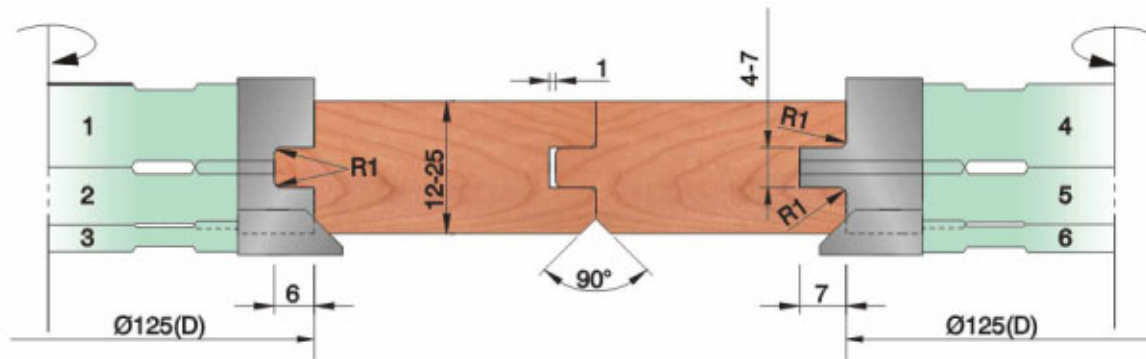

TF601J D125*W12~25*d40*Z4/Z6 1SET/6PCS

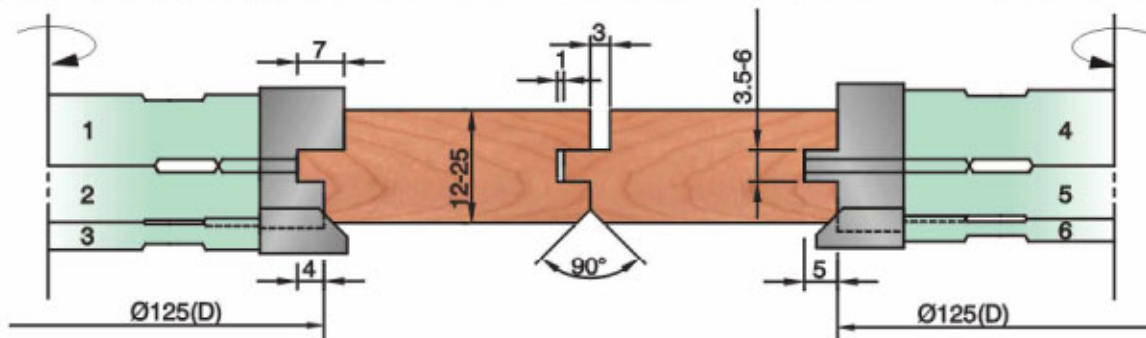

Carbide-Tipped Adjustable Tongue & Groove Flooring Cutter Sets

(Brazed T.C.T thickness 4mm)



TF601K D125*W12~25*d40*Z4/Z6 1SET/8PCS

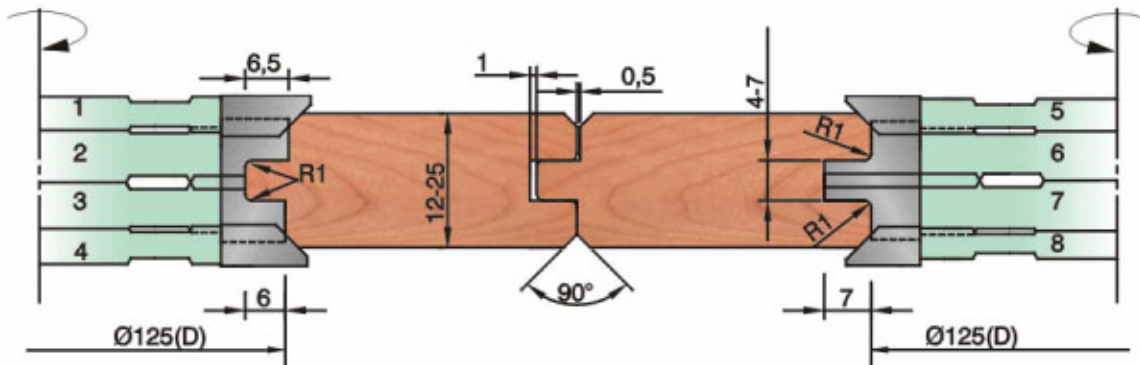

TF601L D125*W12~25*d40*Z4/Z6 1SET/8PCS

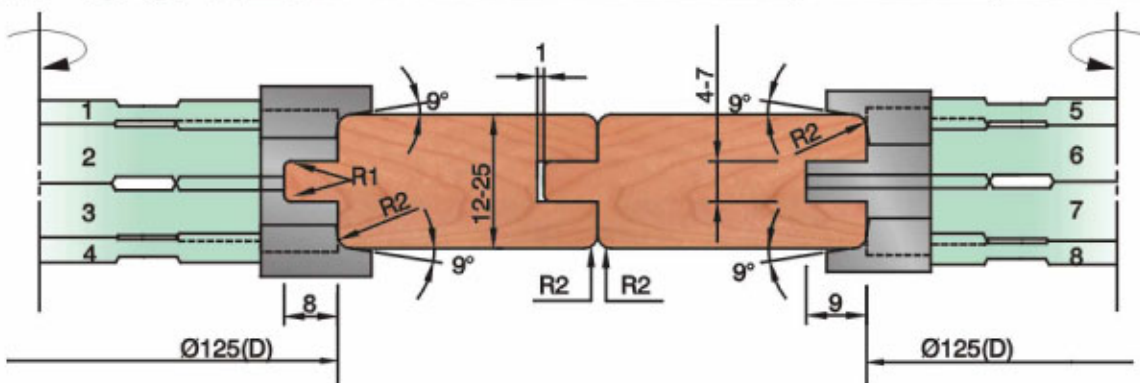

TF601M D125*W12~25*d40*Z4/Z6 1SET/8PCS

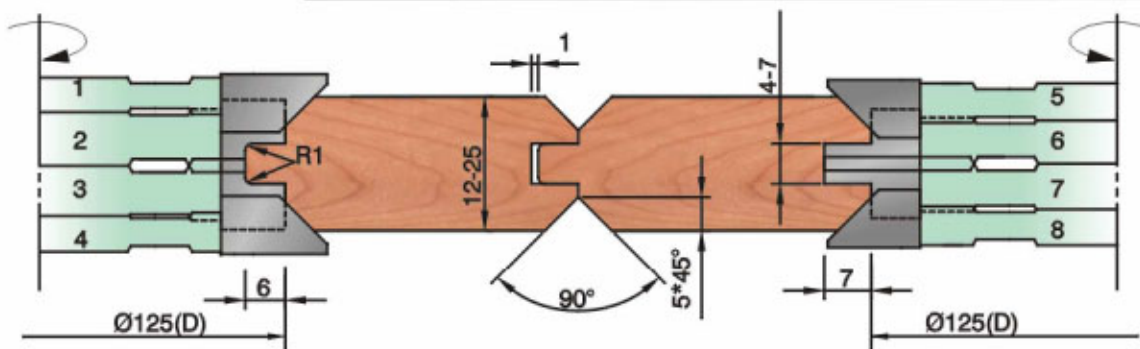

Carbide-Tipped Adjustable Tongue & Groove Wall Panel Cutter Sets

(Braze T.C.T thickness 4mm)



TF601N $\underline{D125*W12\sim20*d40*Z4/Z6}$ 1SET/4PCS

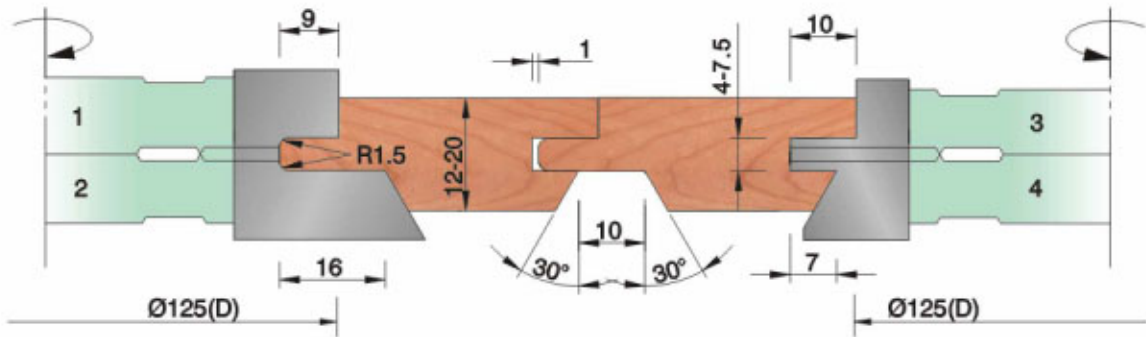

TF601P $\underline{D125*W12\sim20*d40*Z4/Z6}$ 1SET/4PCS

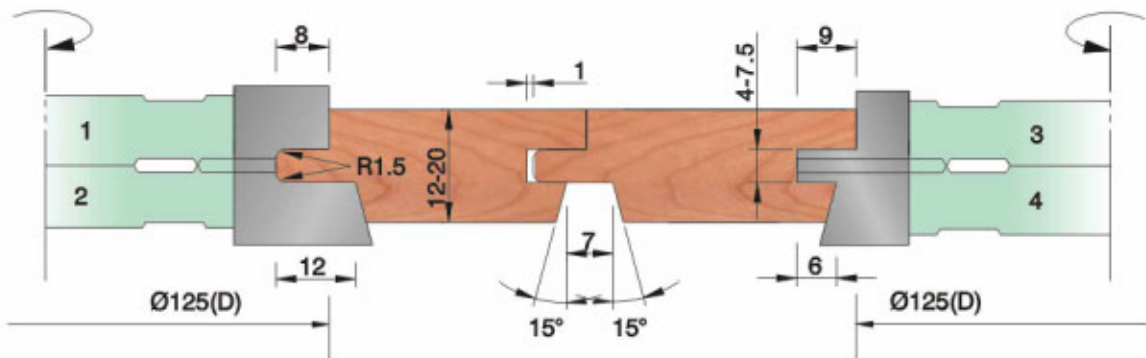

TF601Q $\underline{D125*W12\sim20*d40*Z4/Z6}$ 1SET/4PCS

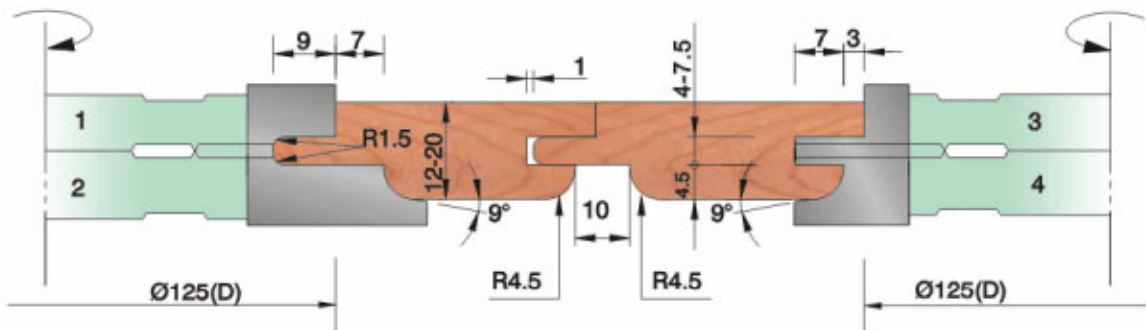

• Special specifications is available as per custom's order

Carbide-Tipped Adjustable Tongue & Groove Wall Panel Cutter Sets

(Brazed T.C.T thickness 4mm)

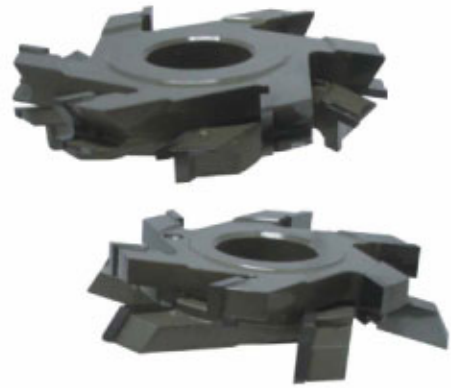

TF601R D125*W12-20mm*d40*Z4/Z6 1SET/4PCS

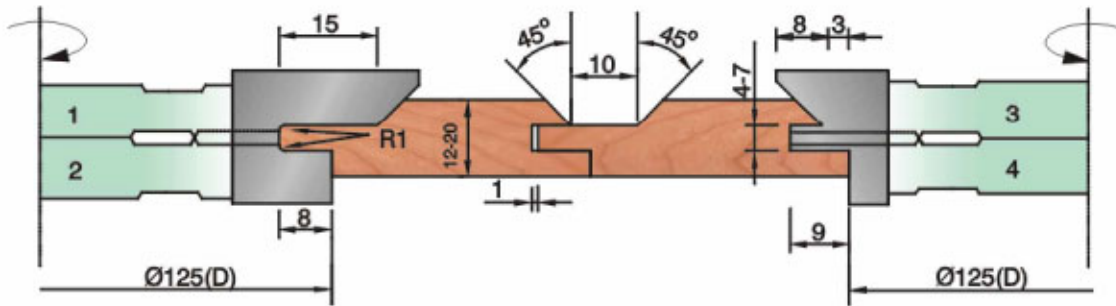

TF601S D125*W12-20mm*d40*Z4/Z6 1SET/4PCS

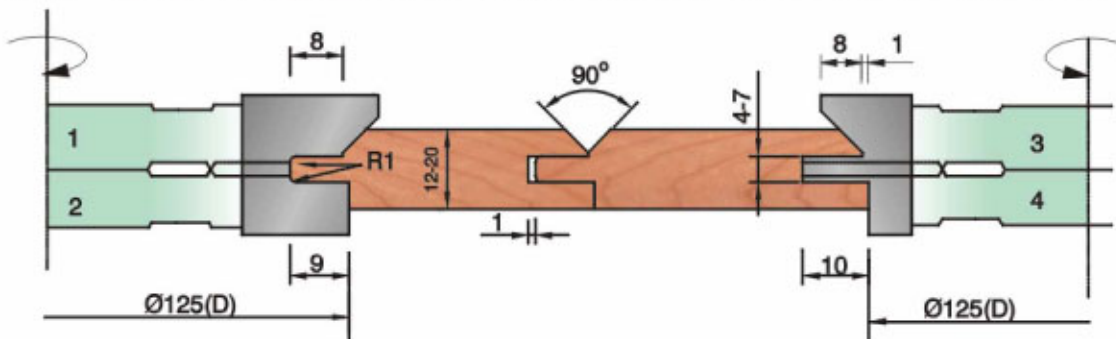

TF601T D125*W12-20mm*d40*Z4/Z6 1SET/4PCS

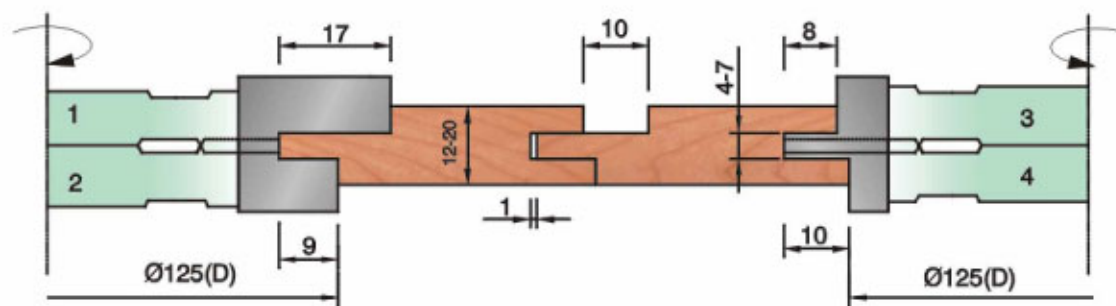

• Special specifications is available as per custom's order

Carbide-Tipped Adjustable Tongue & Groove Flooring Cutter Sets

(Brazed T.C.T thickness 4mm)



TF601U D140*W12~25*d40*Z6/Z8 1SET/4PCS

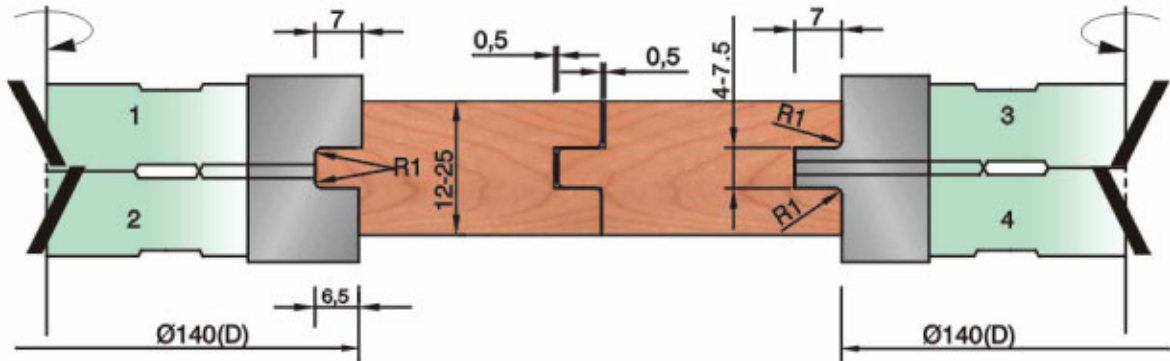

TF601V D140*W12~25*d40*Z6/Z8 1SET/4PCS

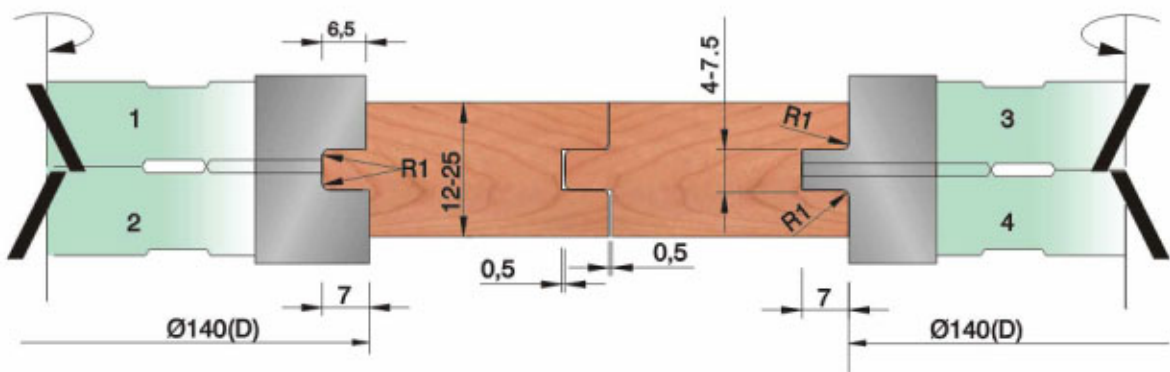

TF601W D140*W12~25*d40*Z6/Z8 1SET/6PCS

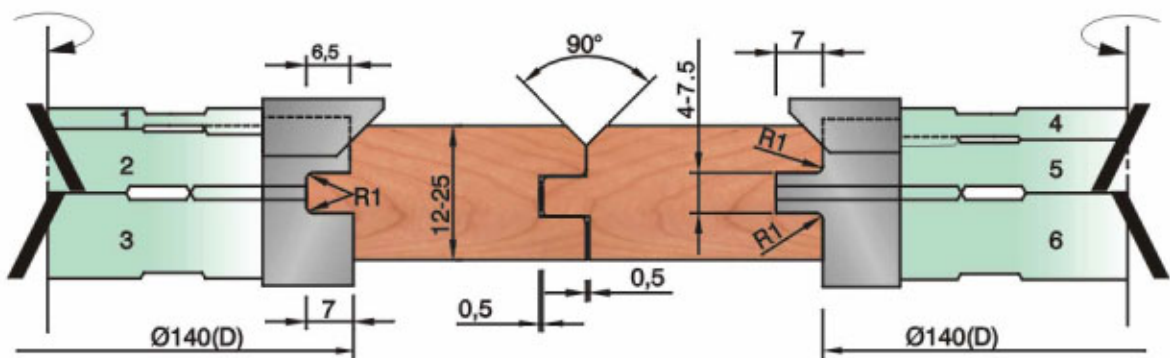

• Special specifications is available as per custom's order

Grooving Cutters For Flooring

(Brazed T.C.T thickness 4mm)



TF602D D125*d40*Z4

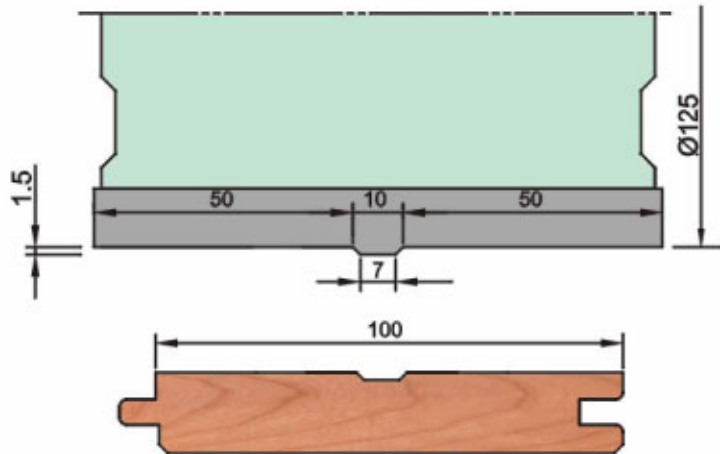

TF602E D125*d40*Z4

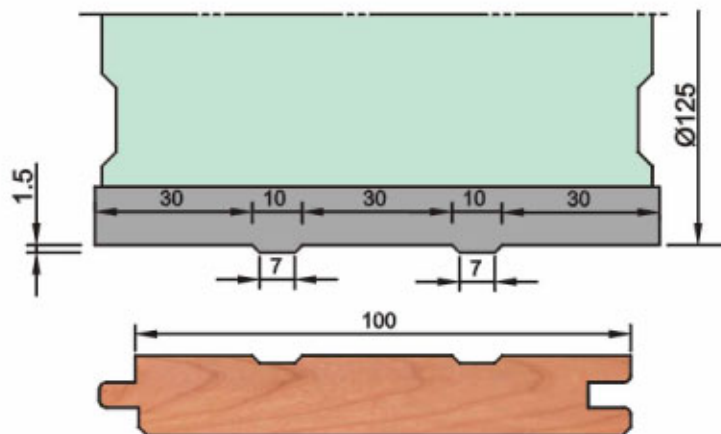

TF602F D125*d40*Z4

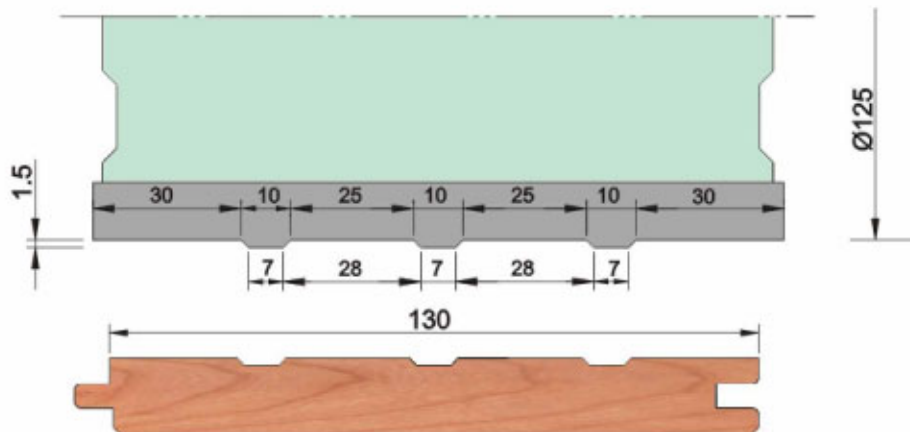

• Special specifications is available as per custom's order

Carbide-Tipped Adjustable Stile & Rail Exterior Door Cutter Sets

(Brazeed T.C.T thickness 4mm)

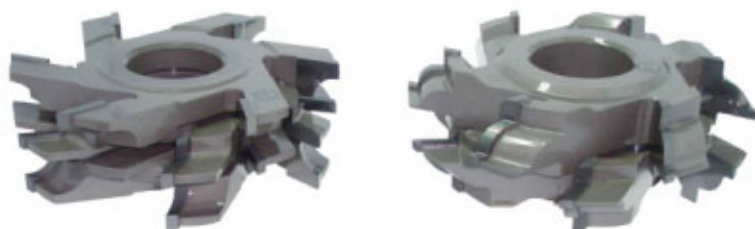

TF603A D140*W36~42*d40*Z4 1SET/6PCS

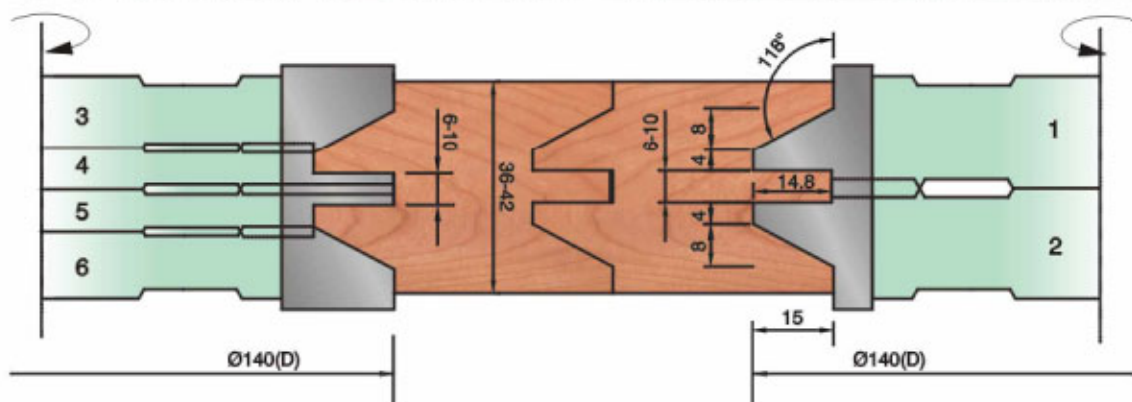

TF603B D140*W38~45*d40*Z4 1SET/6PCS

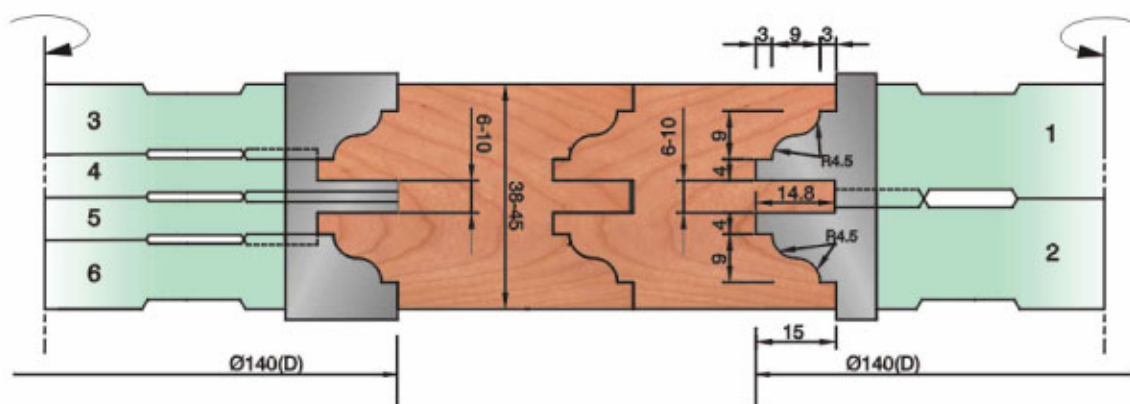

TF603C D140*W40~45**d40*Z4 1SET/6PCS

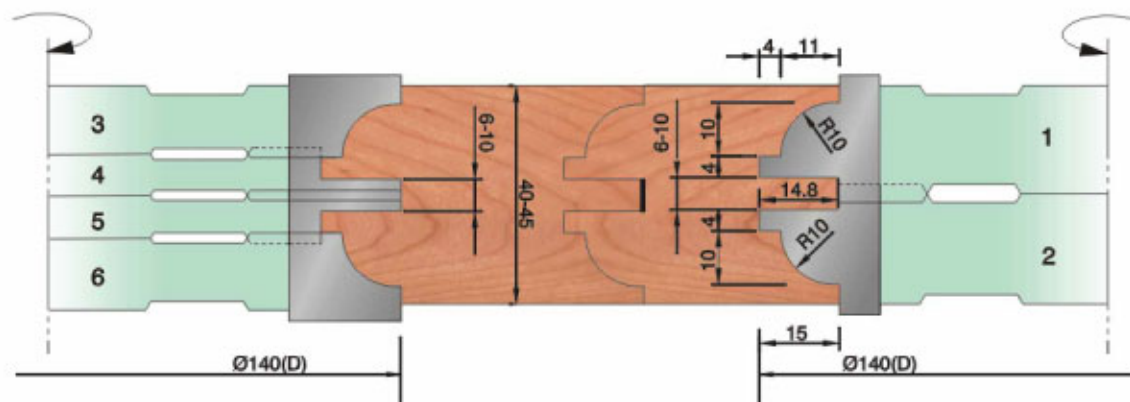

• Special specifications is available as per custom's order.

Carbide-Tipped Adjustable Stile & Rail Exterior Door Cutter Sets

(Braze T.C.T thickness 4mm)



TF603D D140*W38~45*d40*Z4 1SET/6PCS

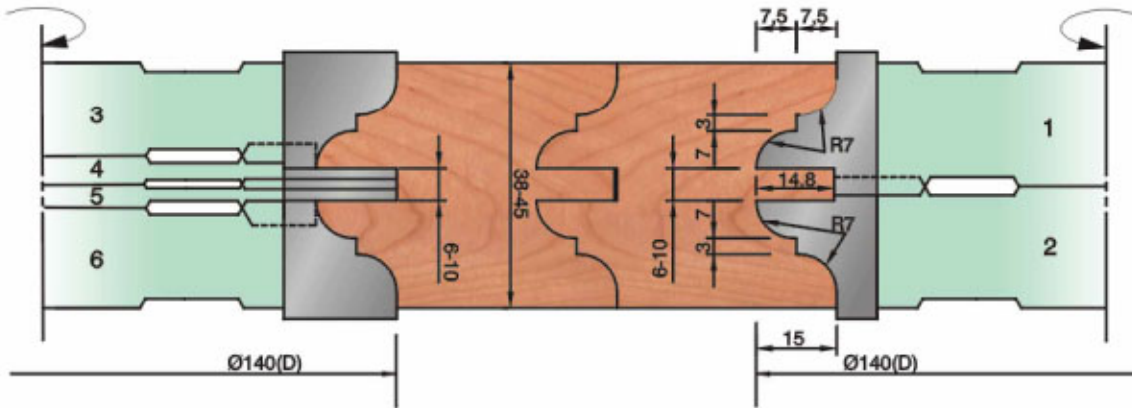

TF603E D140*W40~45*d40*Z4 1SET/6PCS

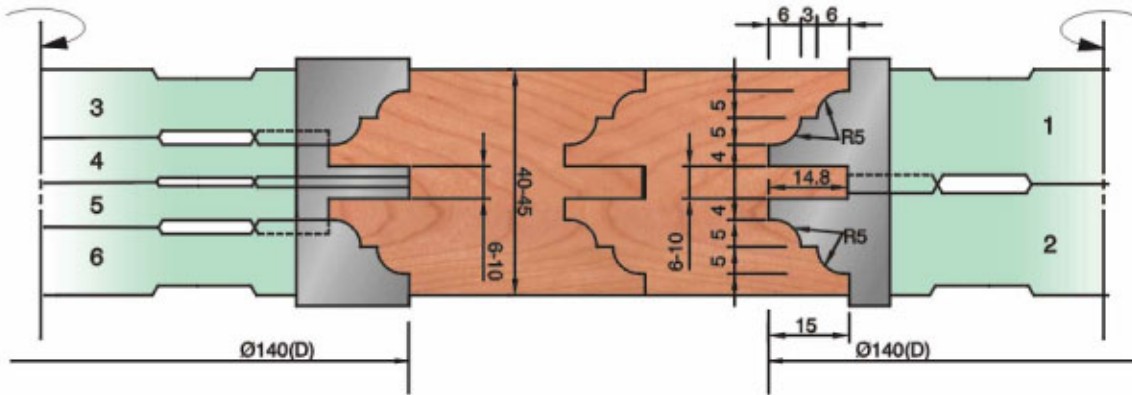

TF603F D140*W38~45*d40*Z4 1SET/6PCS

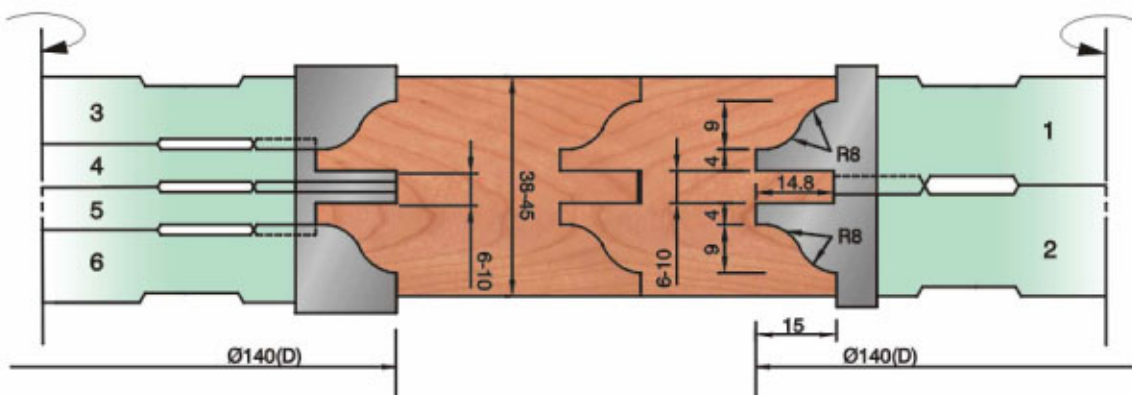

• Special specifications is available as per custom's order

Carbide-Tipped Adjustable Stile & Rail Cabinet Door Cutter Sets

(Brazed T.C.T thickness 4mm)



TF605A $D125*W22\sim30*d30*Z4$ 1SET/5PCS

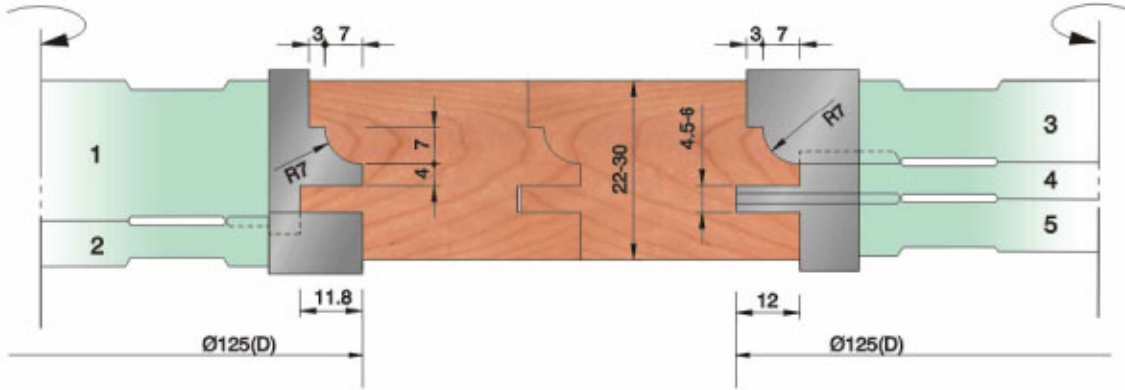

TF605B $D125*W22\sim30*d30*Z4$ 1SET/5PCS

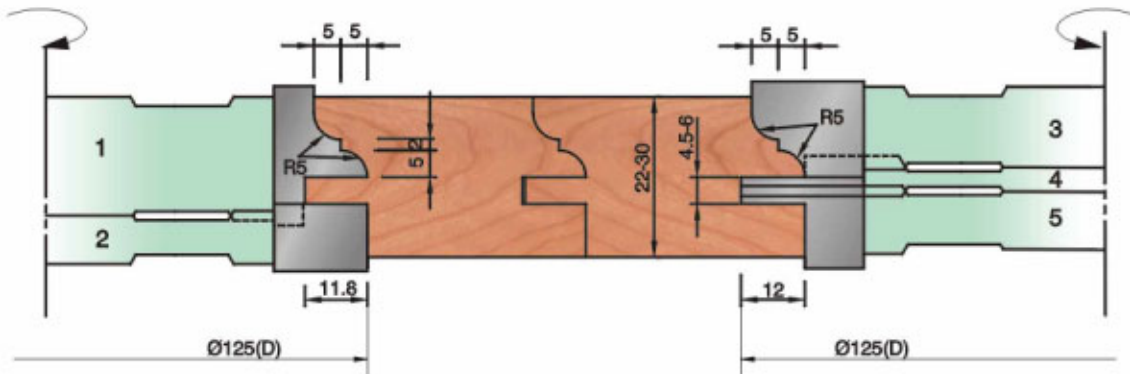

TF605C $D125*W22\sim30*d30*Z4$ 1SET/5PCS

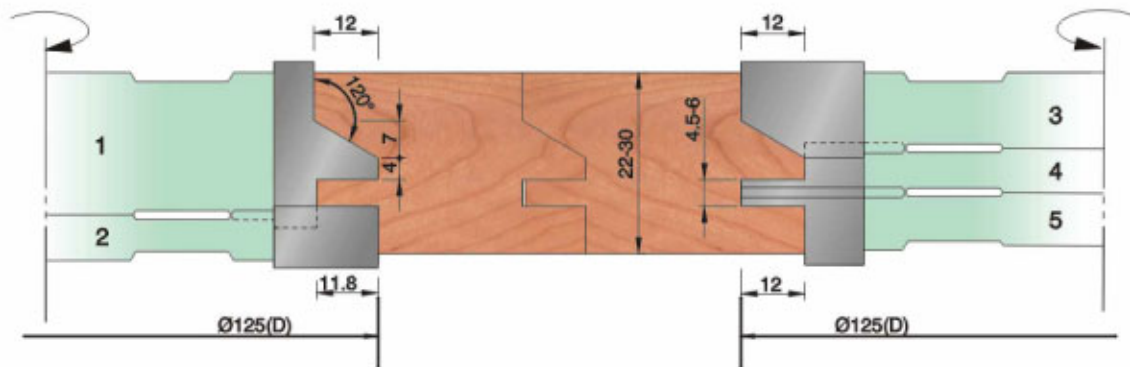

• Special specifications is available as per custom's order.

Carbide-Tipped Adjustable Stile & Rail Cabinet Door Cutter Sets

(Brazed T.C.T thickness 4mm)



TF605D $D125*W22\sim30*d30*Z4$ 1SET/5PCS

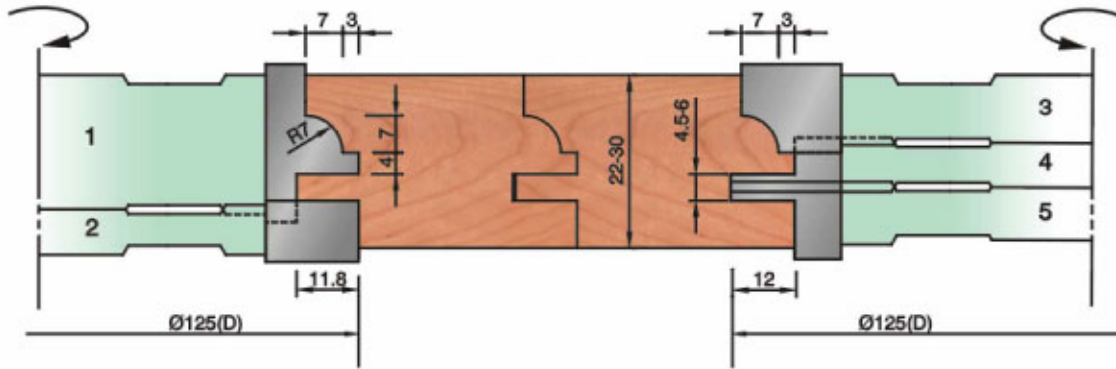

TF605E $D130*W22\sim30*d30*Z4$ 1SET/5PCS

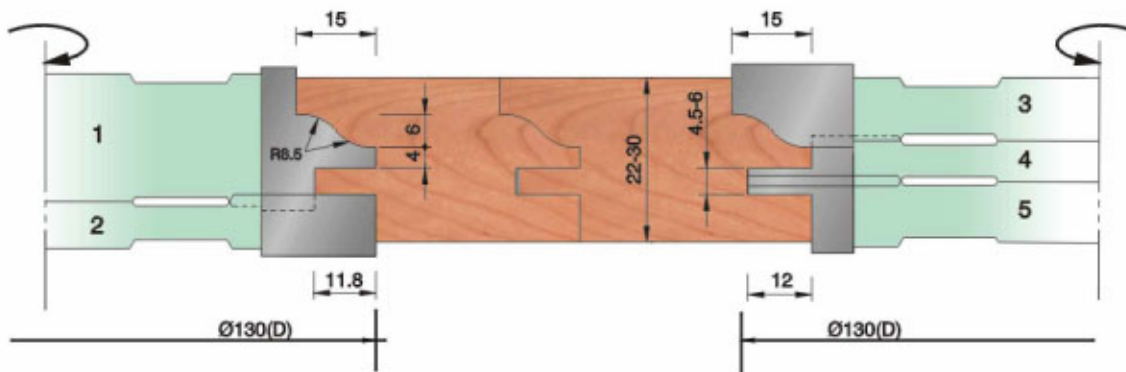

TF605F $D125*W22\sim30*d30*Z4$ 1SET/5PCS

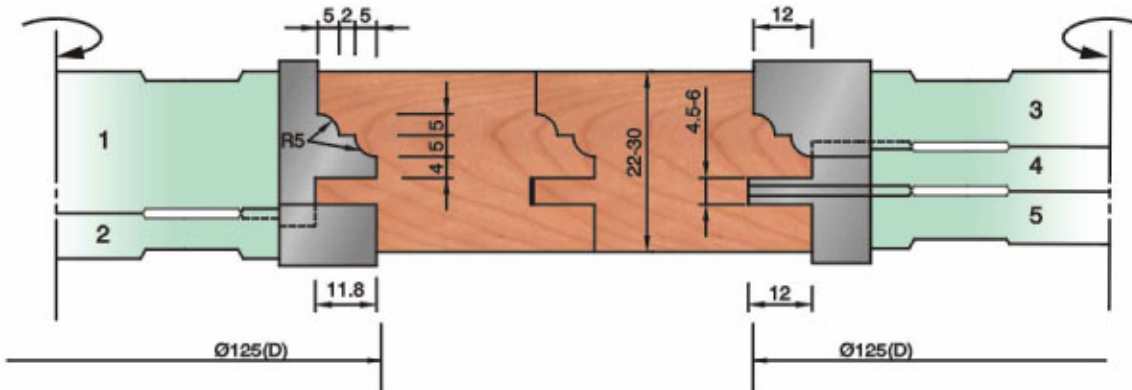

• Special specifications is available as per custom's order.

Carbide-Tipped Adjustable Stile & Rail Glass Door & Mullion Shaper Cutter Sets

(Braze T.C.T thickness 4mm)

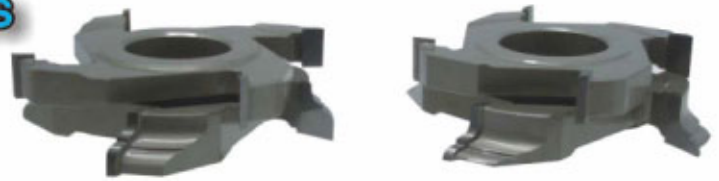

TF606A $D125*W22*d30*Z4$ 1SET/4PCS

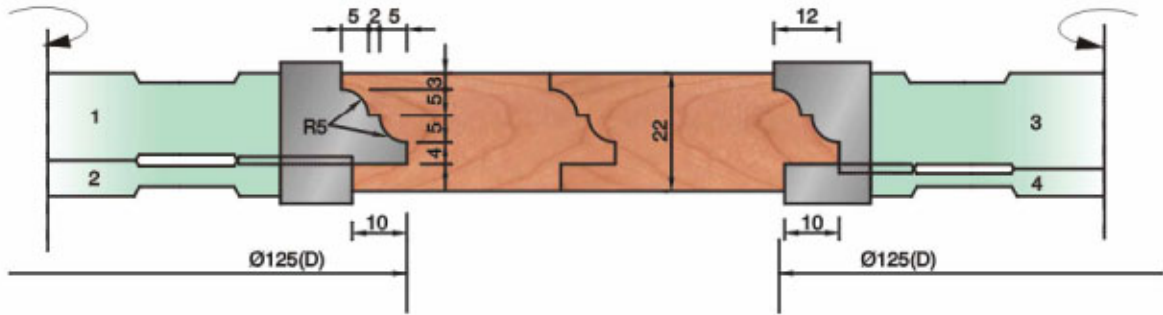

TF606B $D125*W22*d30*Z4$ 1SET/4PCS

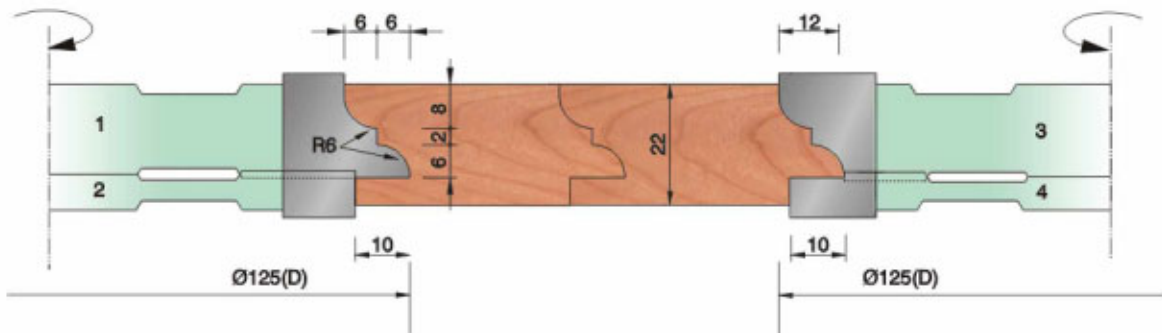

TF606C $D125*W22*d30*Z4$ 1SET/4PCS

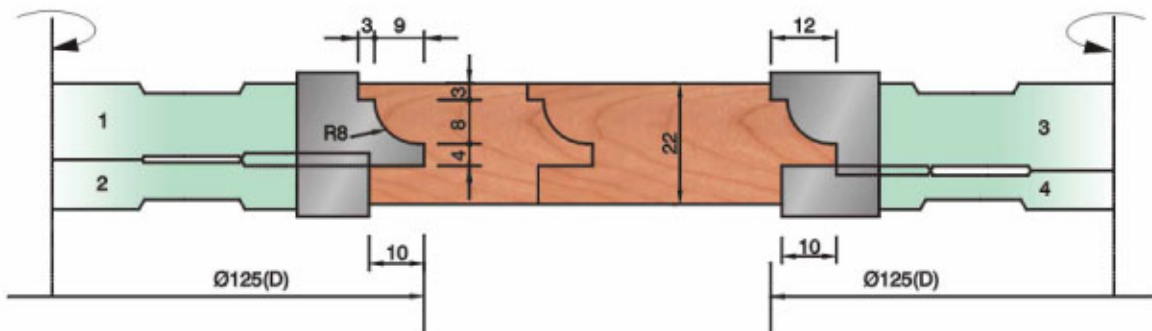

• Special specifications is available as per custom's order.

Carbide-Tipped Adjustable Stile & Rail Glass Door & Mullion Shaper Cutter Sets

(Braze T.C.T thickness 4mm)

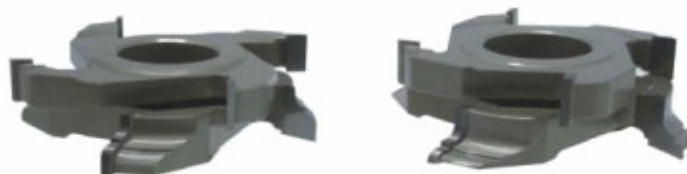

TF606D $D140*W22*d30*Z4$ 1SET/4PCS

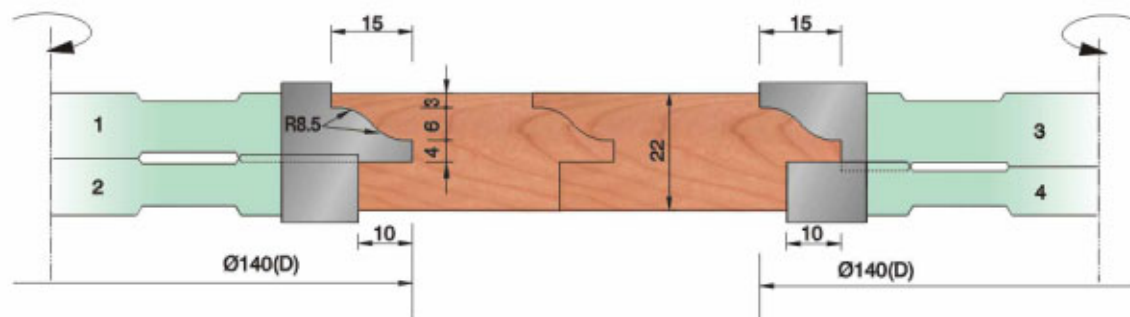

TF606E $D125*W22*d30*Z4$ 1SET/4PCS

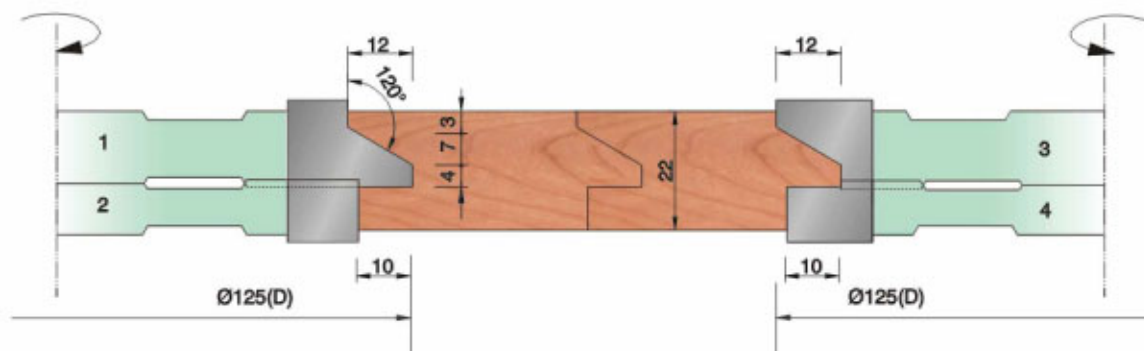

TF606F $D125*W22*d30*Z4$ 1SET/4PCS

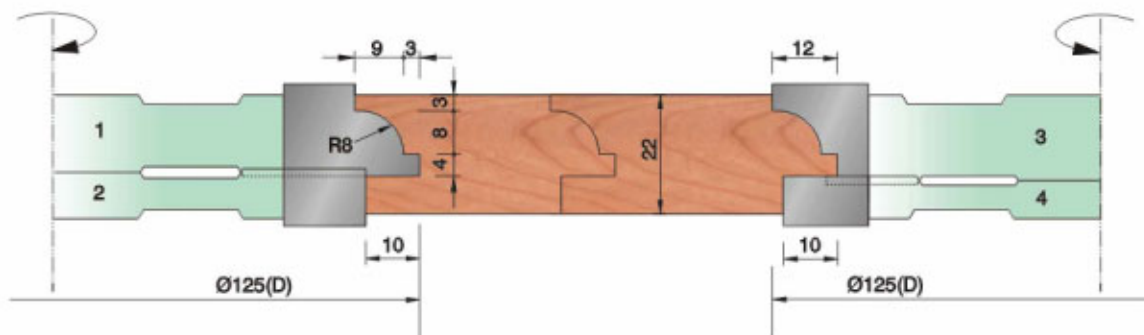

• Special specifications is available as per custom's order.

Carbide-Tipped Raised Panel Shaper Cutters

(Brazed T.C.T thickness 4mm)



TF608D $\text{D180} \times \text{d30} \times \text{Z4/Z6}$

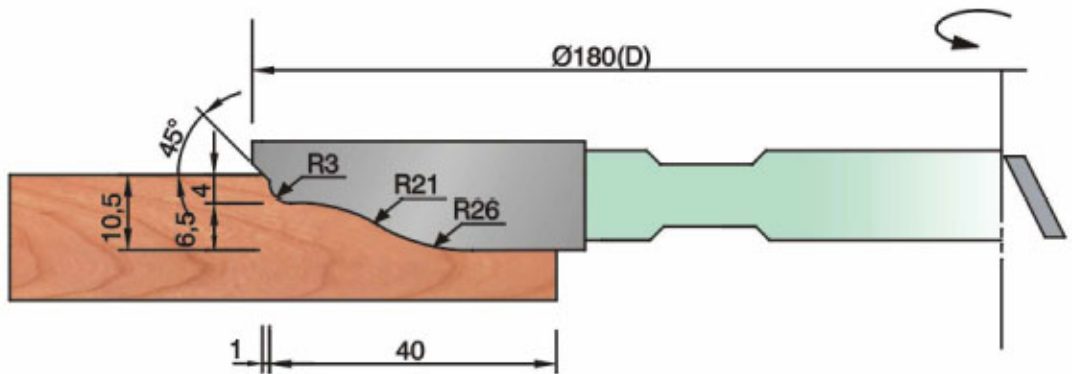

TF608E $\text{D180} \times \text{d30} \times \text{Z4/Z6}$

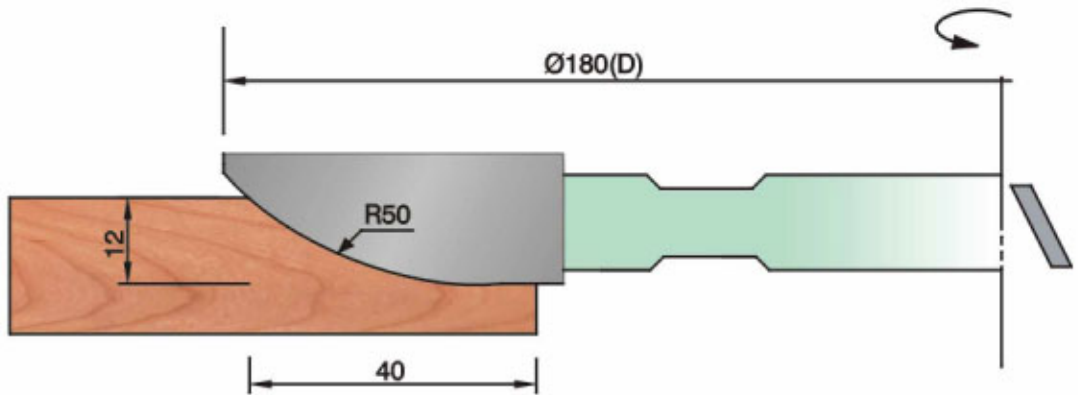

TF608F $\text{D180} \times \text{d30} \times \text{Z4/Z6}$

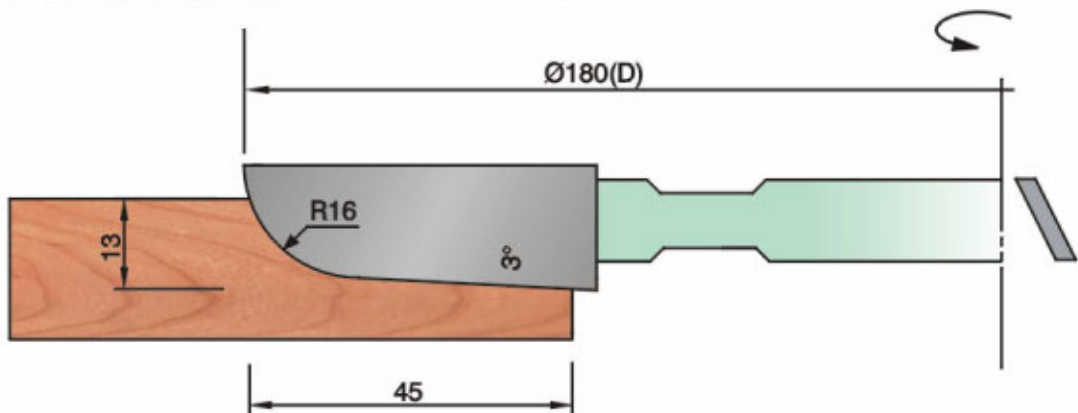

• Special specifications is available as per custom's order.

Carbide-Tipped Raised Panel Shaper Cutters

(Brazed T.C.T thickness 4mm)

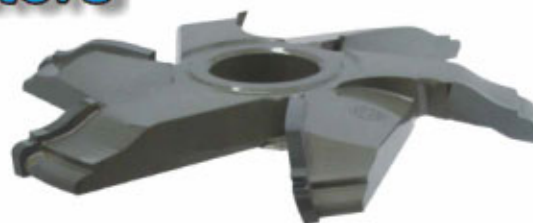

TF608 Carbide-Tipped Raised Panel Shaper Cutters

TF608G $D200*d30*Z4/Z6$

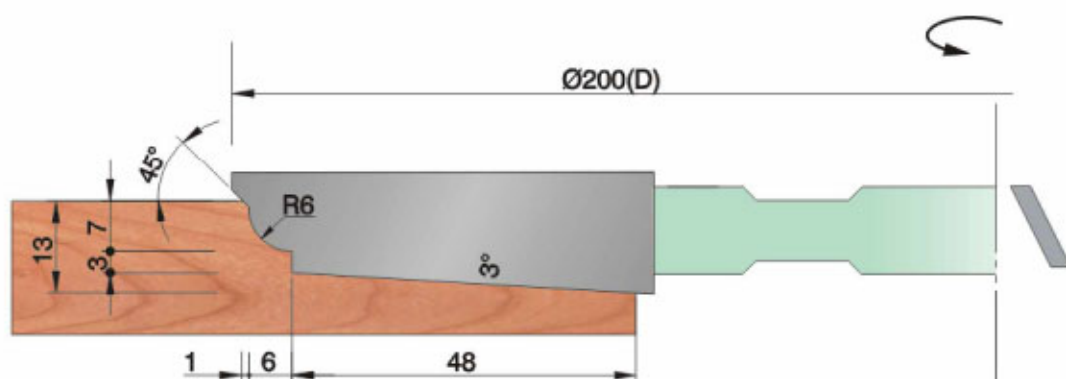

TF608H $D200*d30*Z4/Z6$

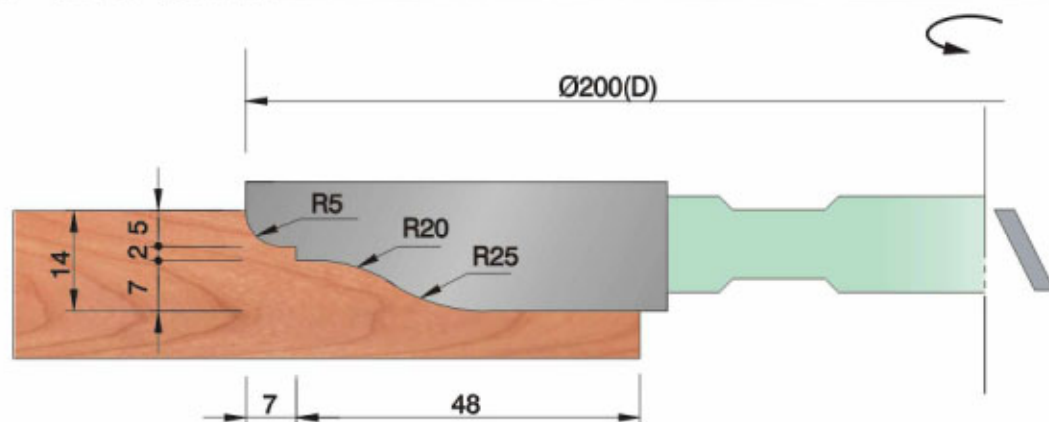

TF608J $D200*d30*Z4/Z6$

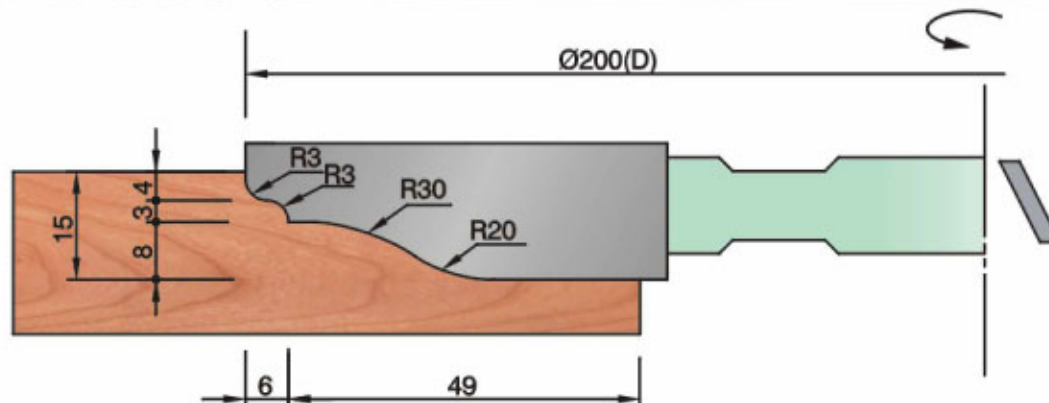

• Special specifications is available as per custom's order.

Carbide-Tipped Raised Panel Shaper Cutter Sets

(Brazed T.C.T thickness 4mm)



TF609A D180*d30*Z4/Z6 1SET/2PCS

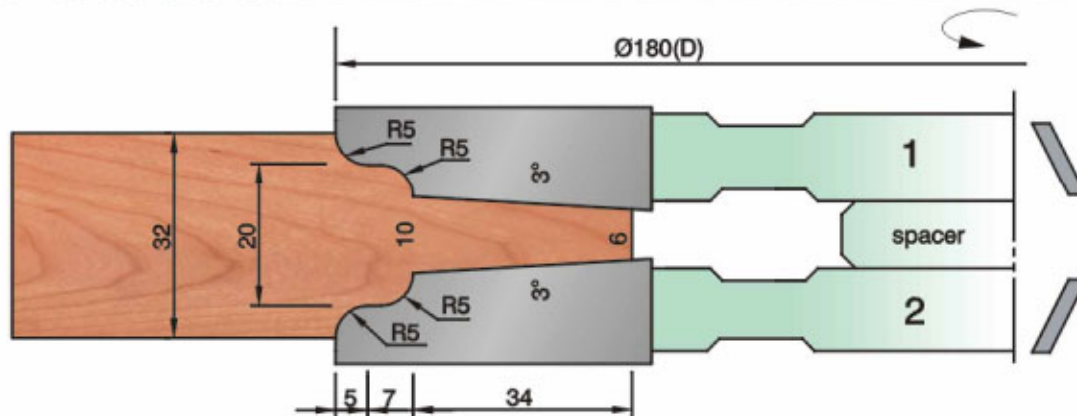

TF609B D180*d30*Z4/Z6 1SET/2PCS

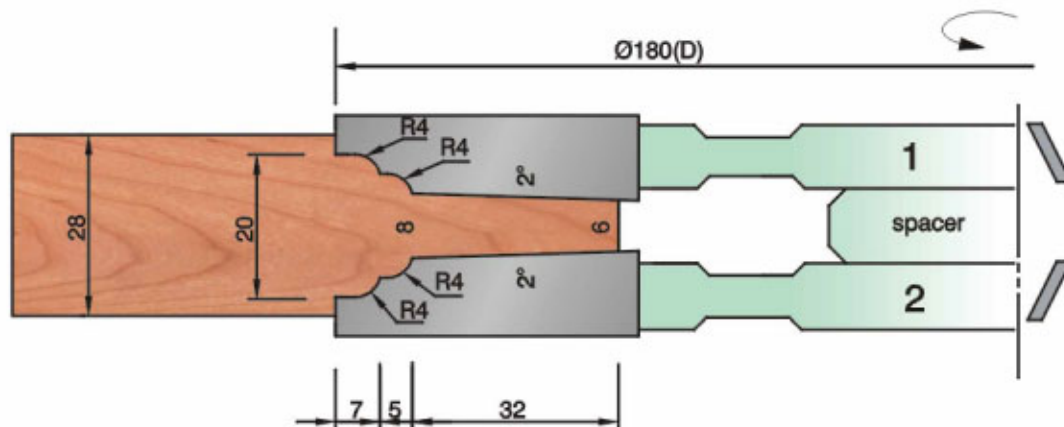

TF609C D180*d30*Z4/Z6 1SET/2PCS

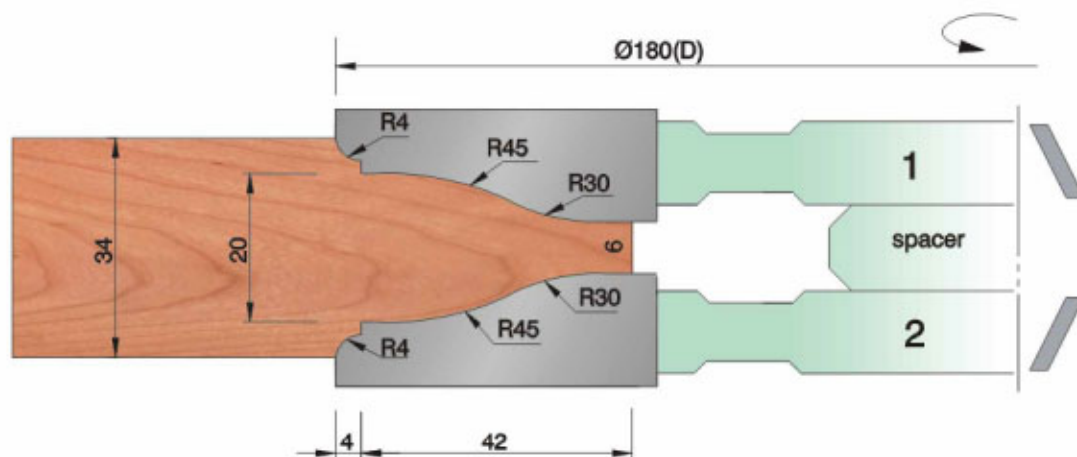

• Special specifications is available as per custom's order.

Carbide-Tipped Raised Panel Shaper Cutter Sets

(Brazed T.C.T thickness 4mm)

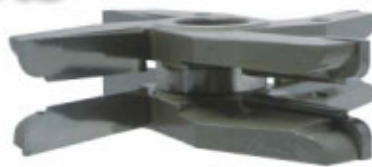

TF609D D180*d30*Z4/Z6 1SET/2PCS

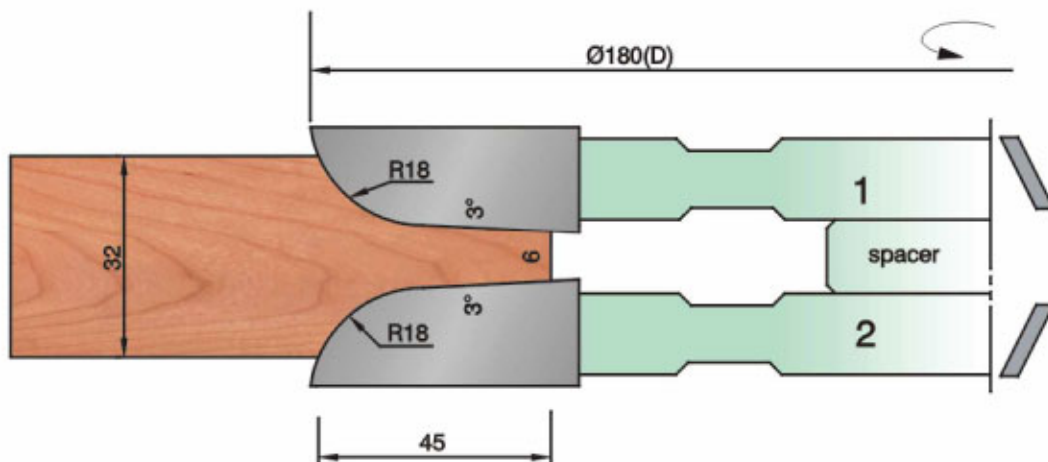

TF609E D180*d30*Z4/Z6 1SET/2PCS

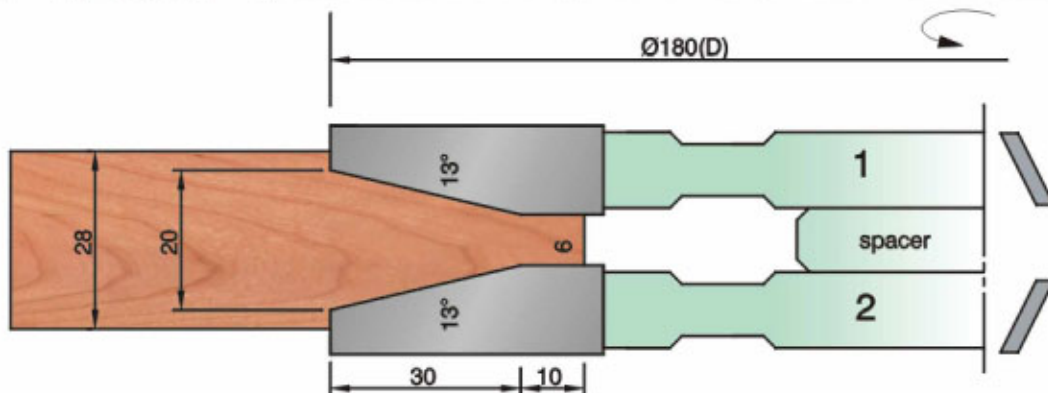

TF609F D180*d30*Z4/Z6 1SET/2PCS

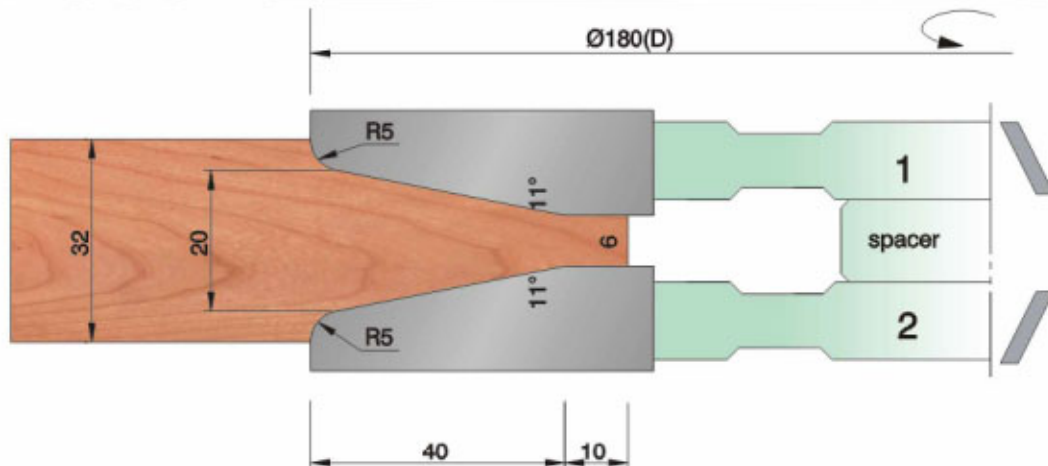

• Special specifications is available as per custom's order.

Carbide-Tipped Finger Joint Shaper Cutters

(Brazed T.C.T thickness 4mm)

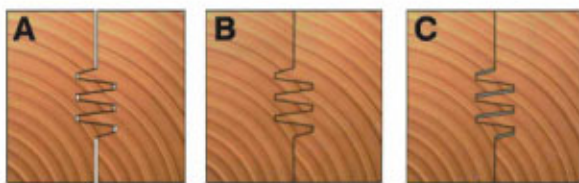

• Tight joint • Regular joint • Loose joint



TF610A $D125*d30*Z4$ 1SET/2PCS

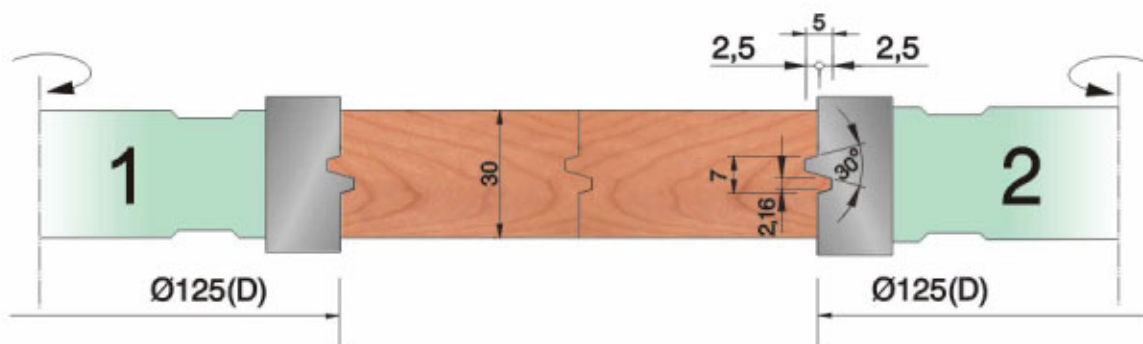

TF610B $D125*d30*Z4$ 1SET/2PCS

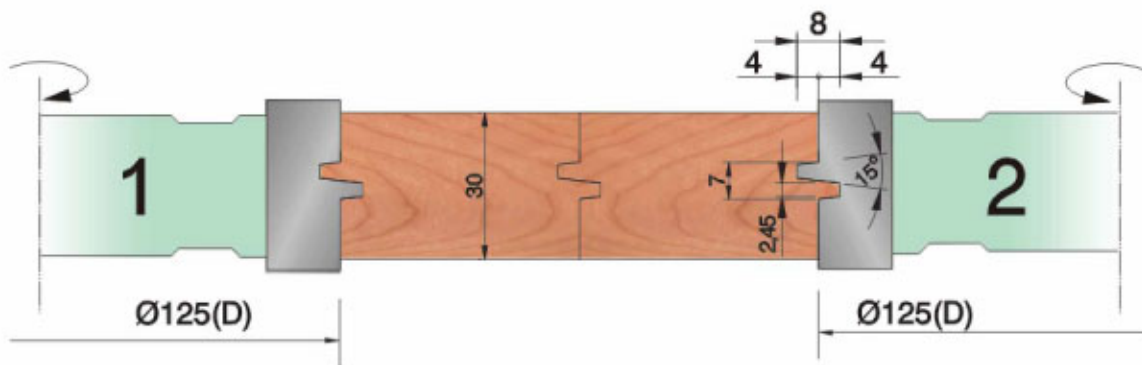

TF610C $D125*d30*Z4$ 1SET/2PCS

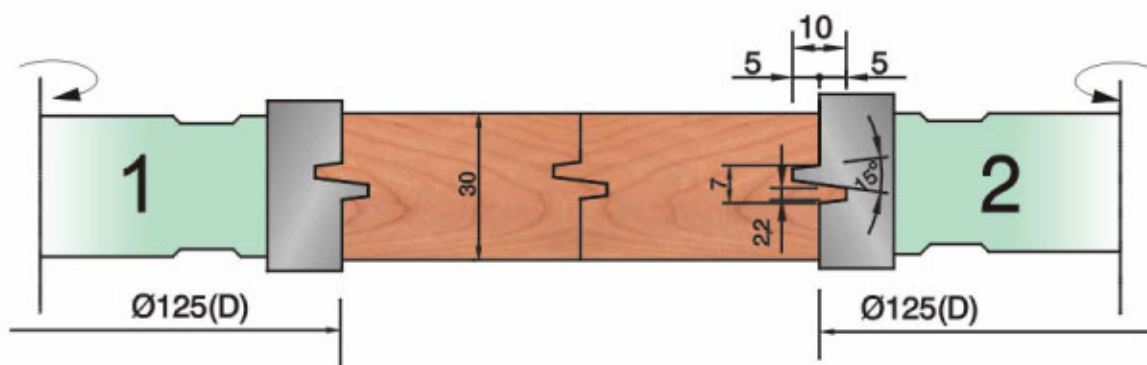

• Special specifications is available as per custom's order

Carbide-Tipped Finger Joint Shaper Cutters

(Brazed T.C.T thickness 4mm)

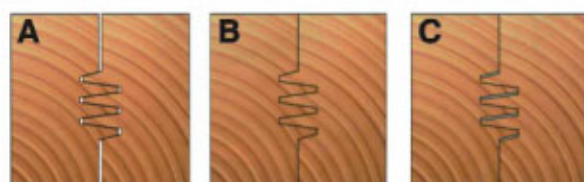

• Tight joint • Regular joint • Loose joint

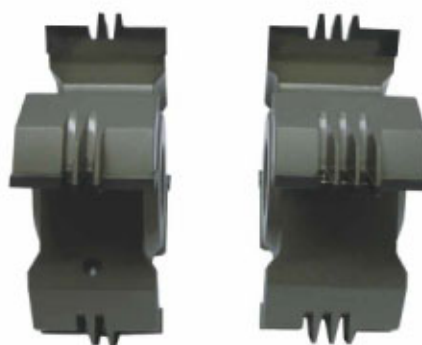

TF610D $\underline{D125*W40*d30*Z4}$ 1SET/2PCS

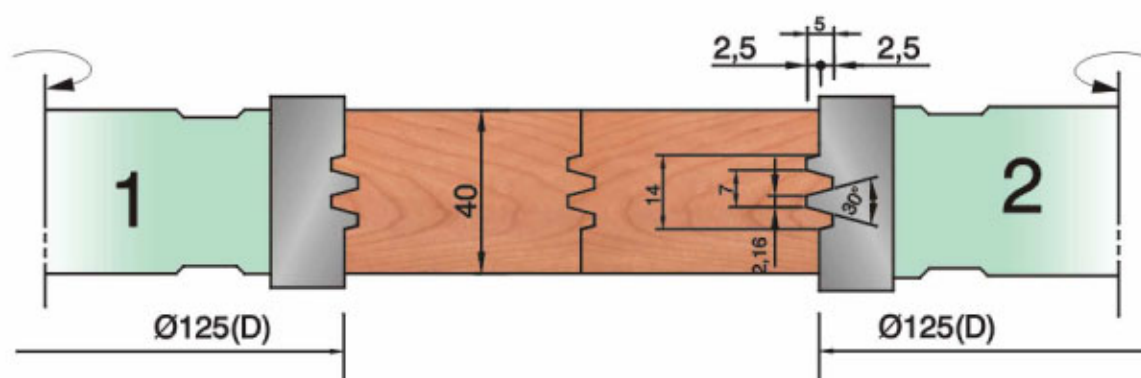

TF610E $\underline{D125*W45*d30*Z4}$ 1SET/2PCS

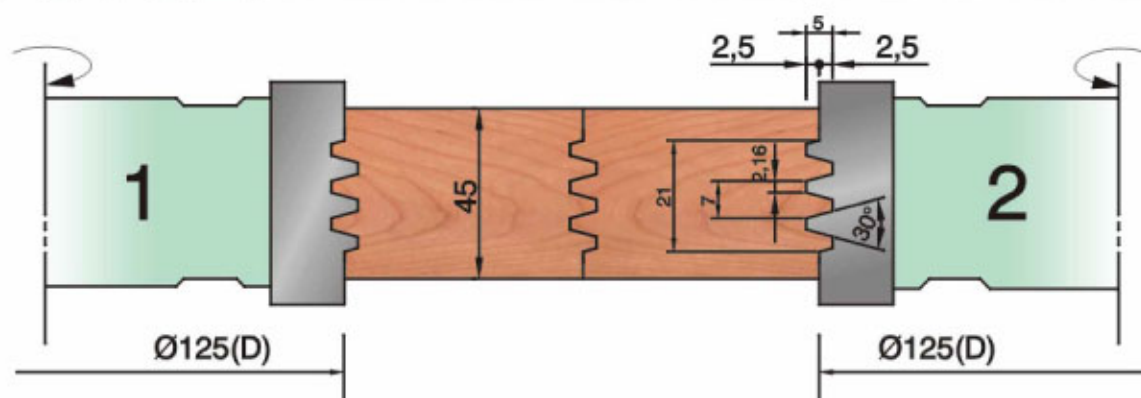

TF610F $\underline{D125*W50*d30*Z4}$ 1SET/2PCS

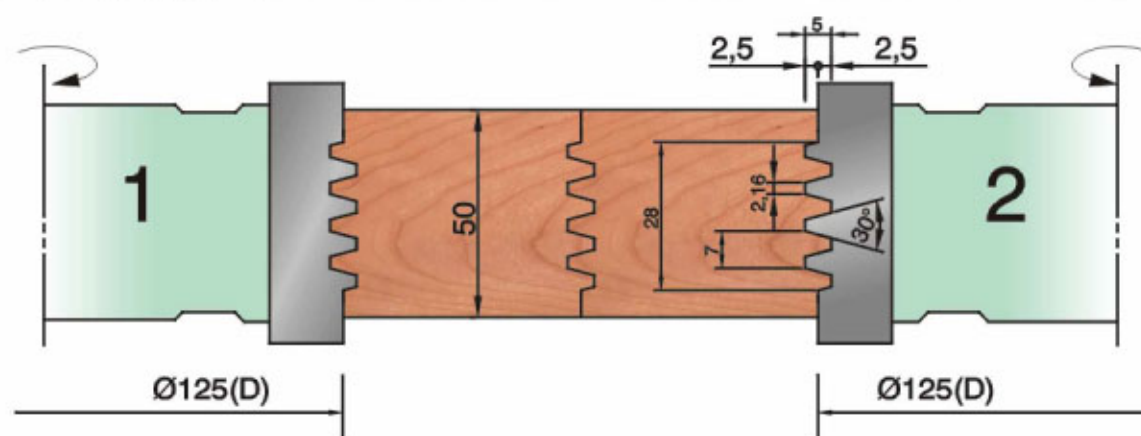

* Special specifications is available as per custom's order

Carbide-Tipped Finger Joint Shaper Cutters

(Brazed T.C.T thickness 4mm)

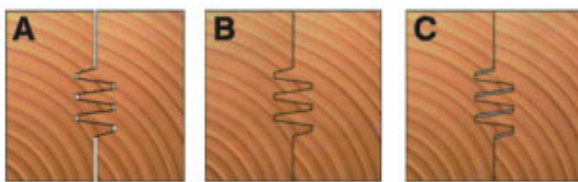

• Tight joint • Regular joint • Loose joint

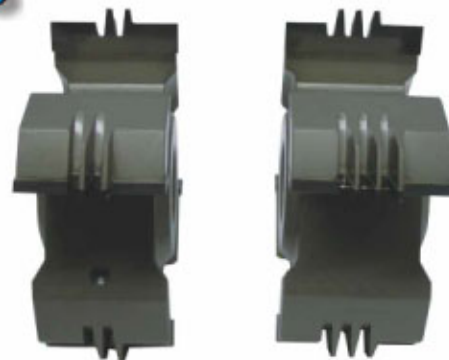

TF610G $\underline{D125*W40*d30*Z4}$ 1SET/2PCS

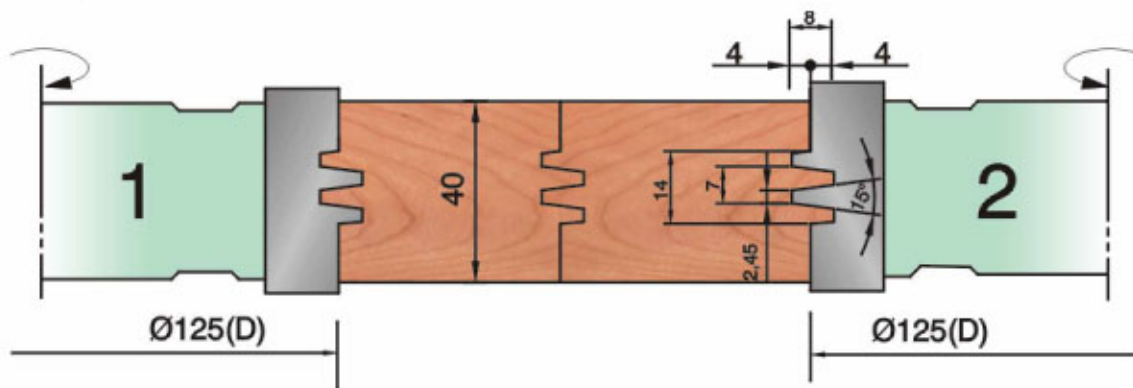

TF610H $\underline{D125*W45*d30*Z4}$ 1SET/2PCS

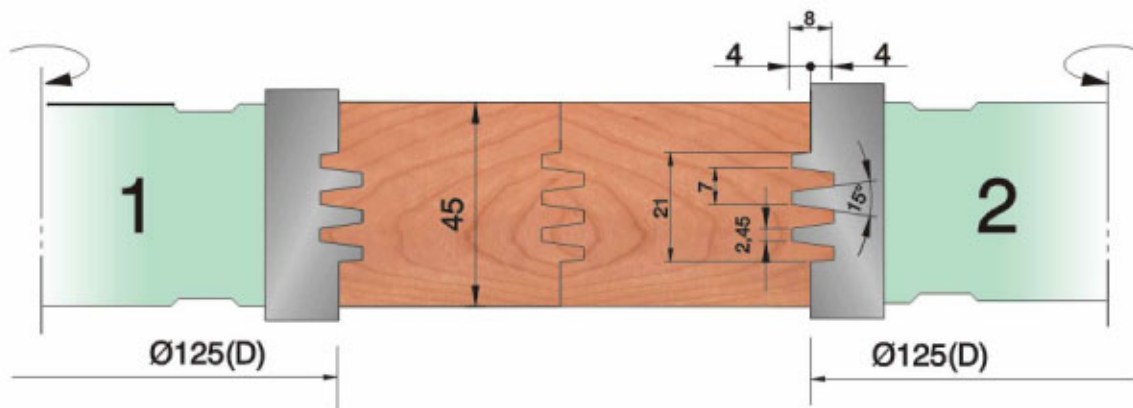

TF610J $\underline{D125*W50*d30*Z4}$ 1SET/2PCS

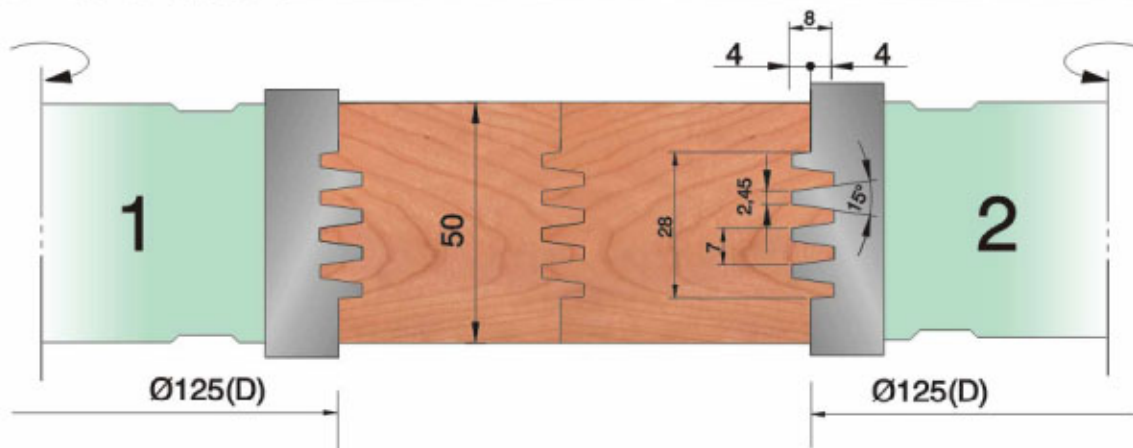

• Special specifications is available as per custom's order

Carbide-Tipped Finger Joint Shaper Cutters

(Brazed T.C.T thickness 4mm)

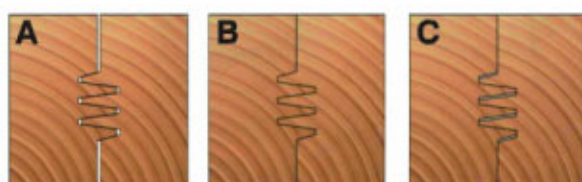

• Tight joint • Regular joint • Loose joint



TF610K D125*W40*d30*Z4 1SET/2PCS

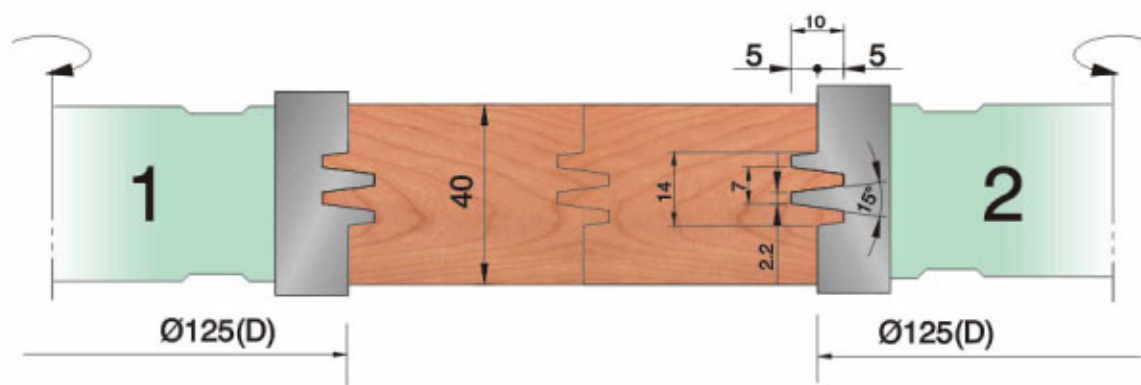

TF610L D125*W45*d30*Z4 1SET/2PCS

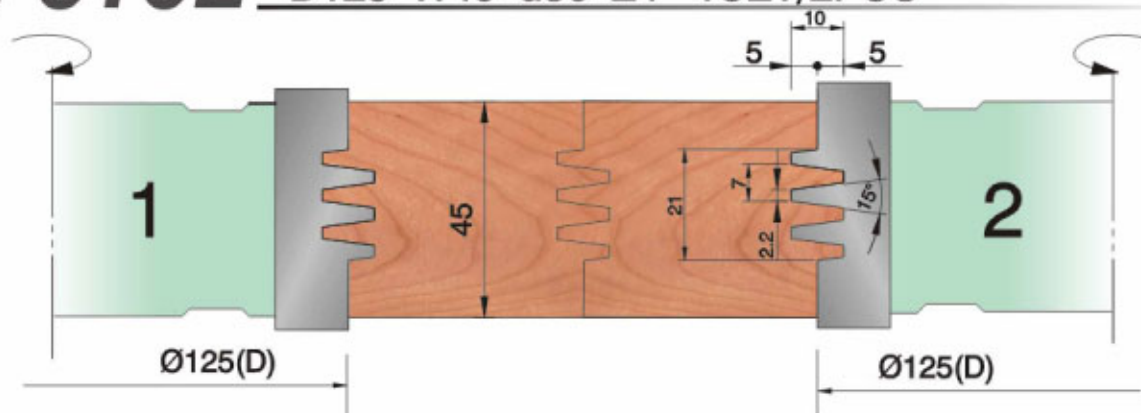

TF610M D125*W50*d30*Z4 1SET/2PCS

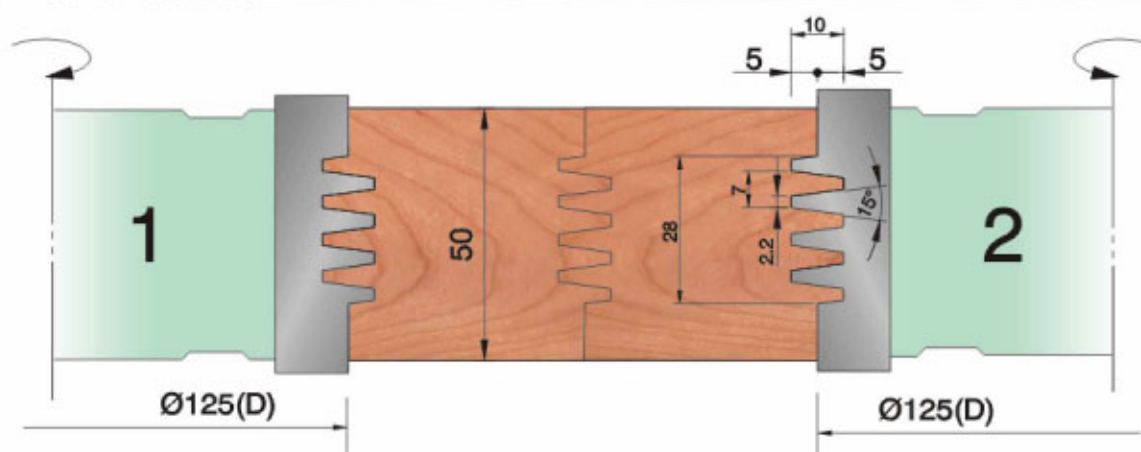

• Special specifications is available as per custom's order

Carbide-Tipped Finger Joint Shaper Cutters

(Brazed T.C.T thickness 4mm)

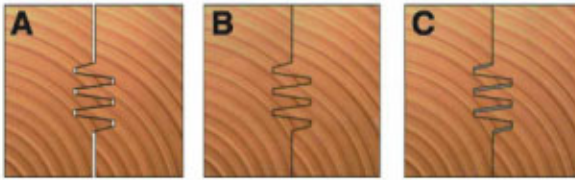

• Tight joint • Regular joint • Loose joint

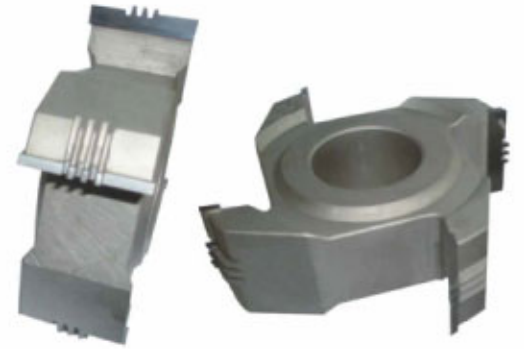

TF610N D125*W40*d30*Z4 1SET/2PCS

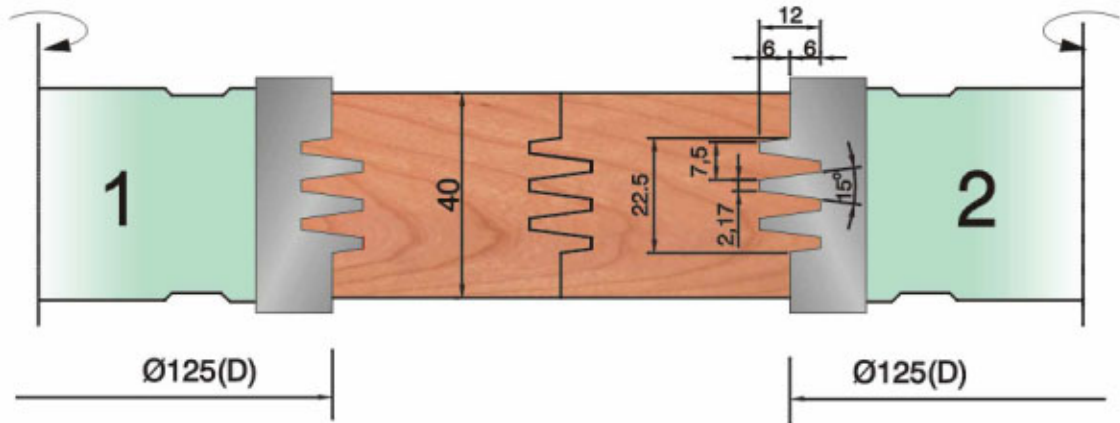

TF610P D125*W45*d30*Z4 1SET/2PCS

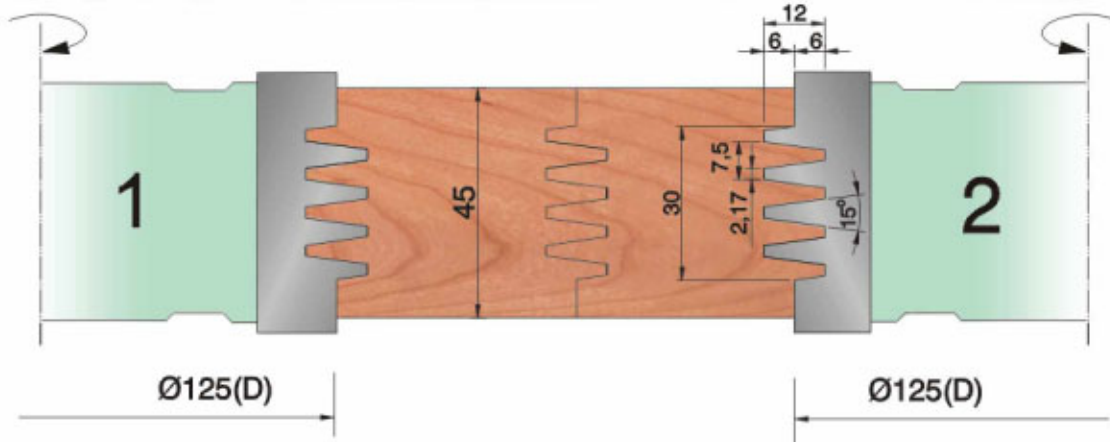

TF610Q D125*W50*d30*Z4 1SET/2PCS

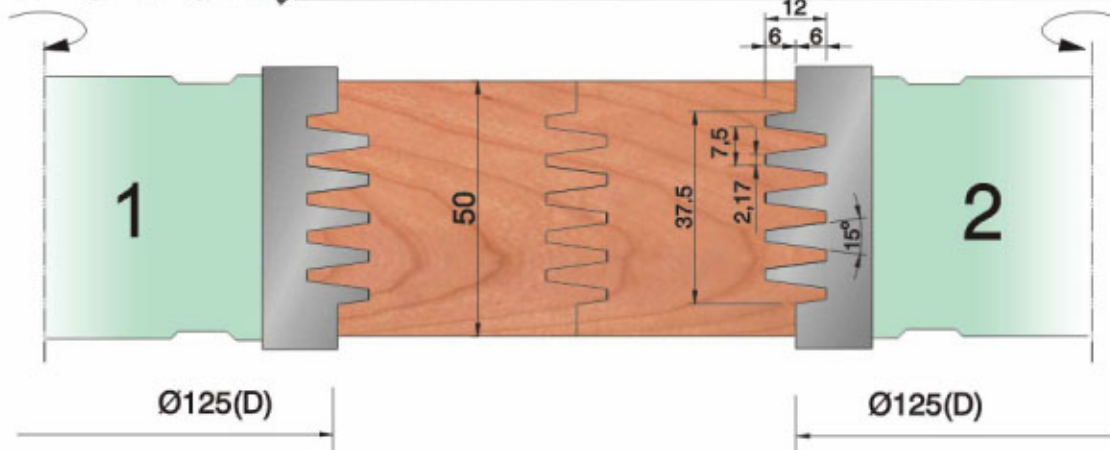

Carbide-Tipped Finger Joint Shaper Cutters

(Brazed T.C.T thickness 4mm)

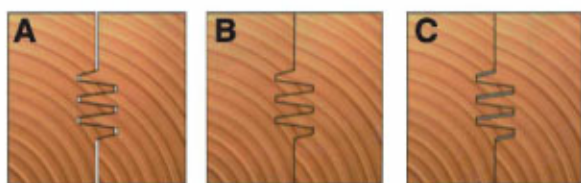

• Tight joint • Regular joint • Loose joint

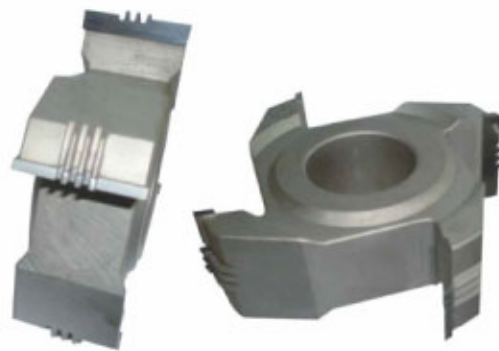

TF610R $D125*W40*d30*Z4$ 1SET/2PCS

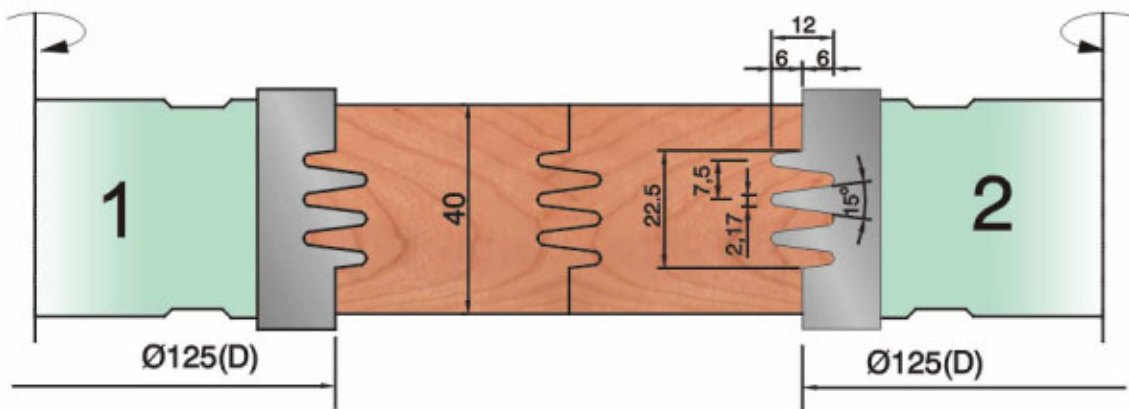

TF610S $D125*W45*d30*Z4$ 1SET/2PCS

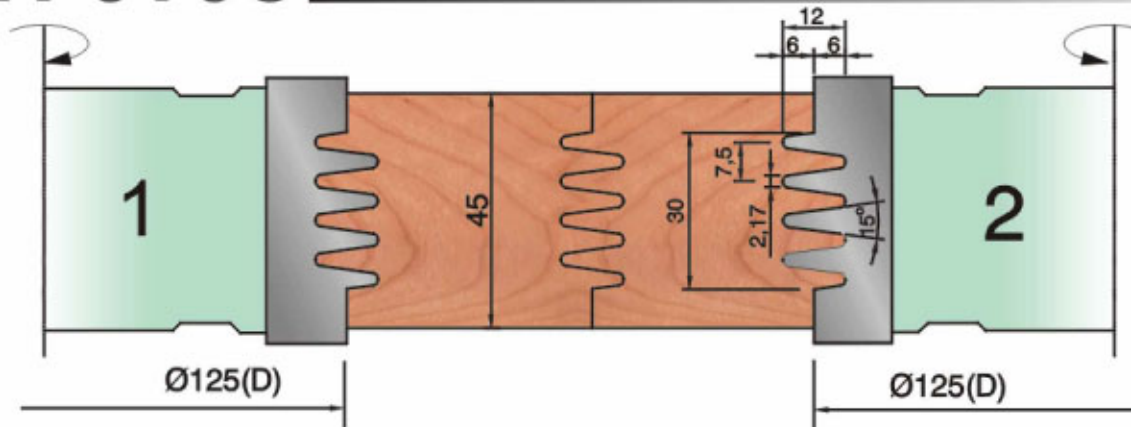

TF610T $D125*W50*d30*Z4$ 1SET/2PCS

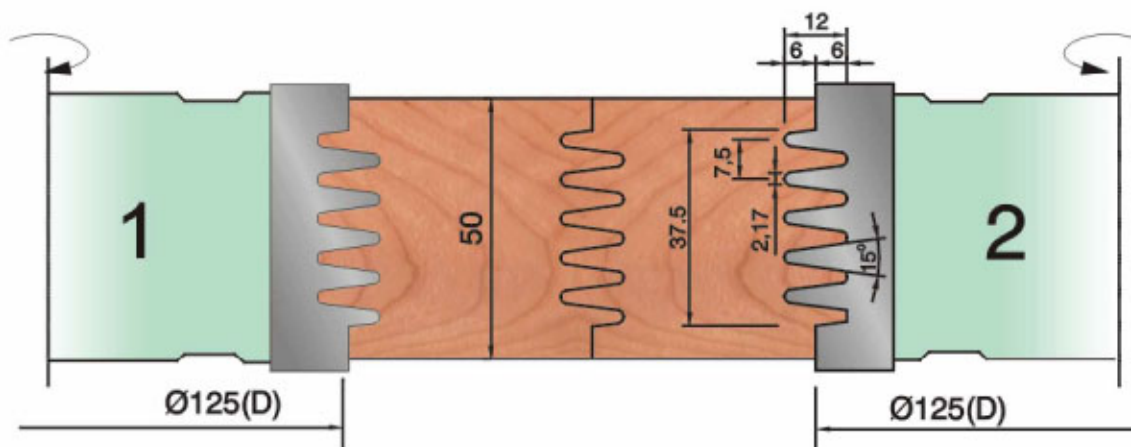

Carbide-Tipped 45° Lock Miter Shaper Cutter Sets

(Brazed T.C.T thickness 4mm)



TF612 D170*W16-30mm *d30*Z4 1SET/2PCS

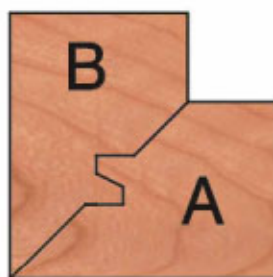
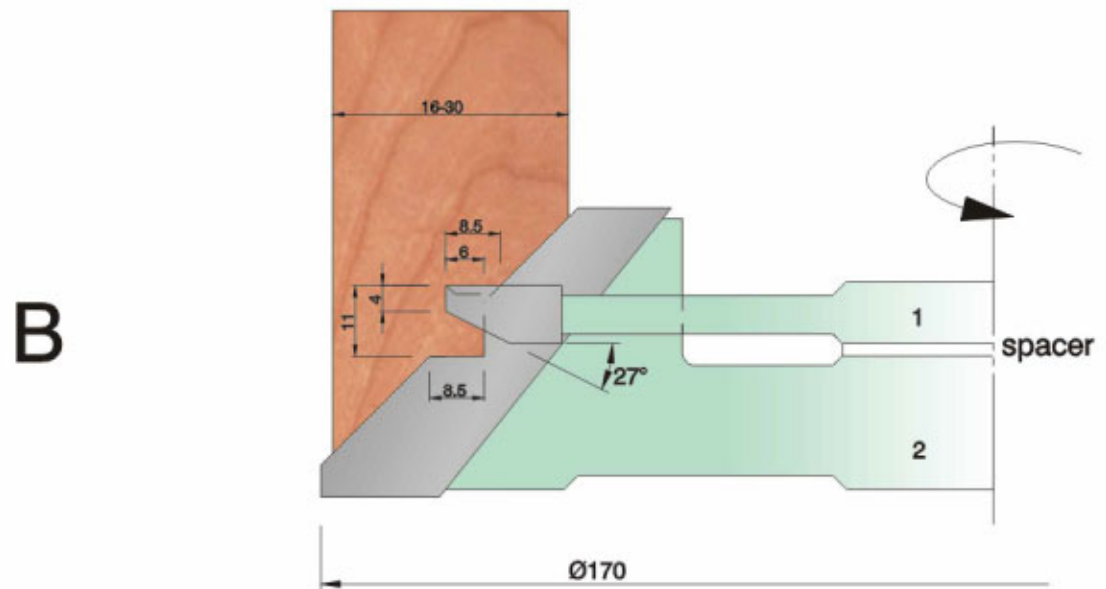
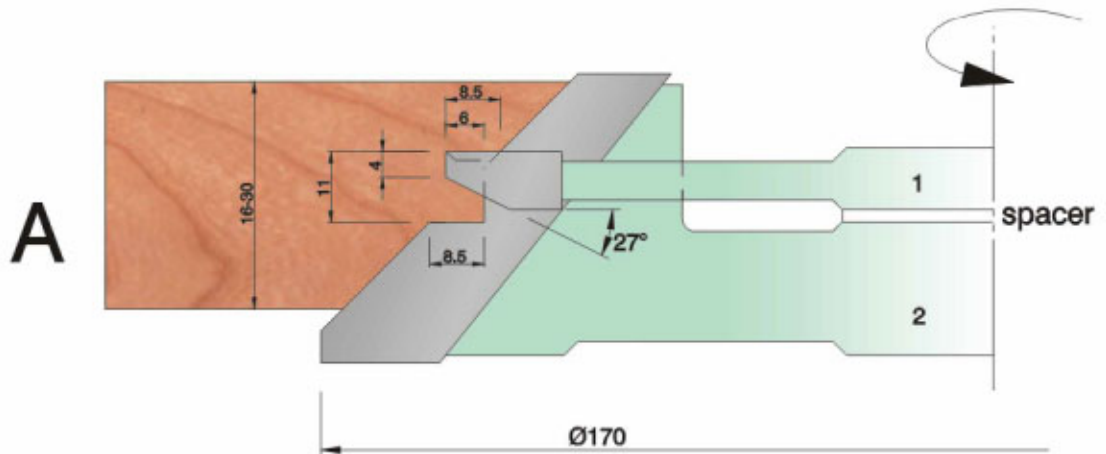

Simple Joint



Simple Joint

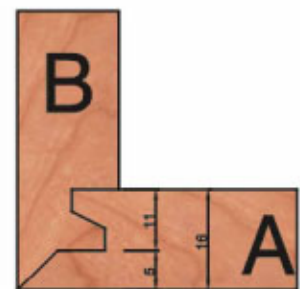

Simple Joint

Carbide-Tipped Adjustable Finger Joint Shaper Cutter Sets

(Brazed T.C.T thickness 4mm)

TF616 D125*W34-48mm*d30*dZ4 1SET/2PCS

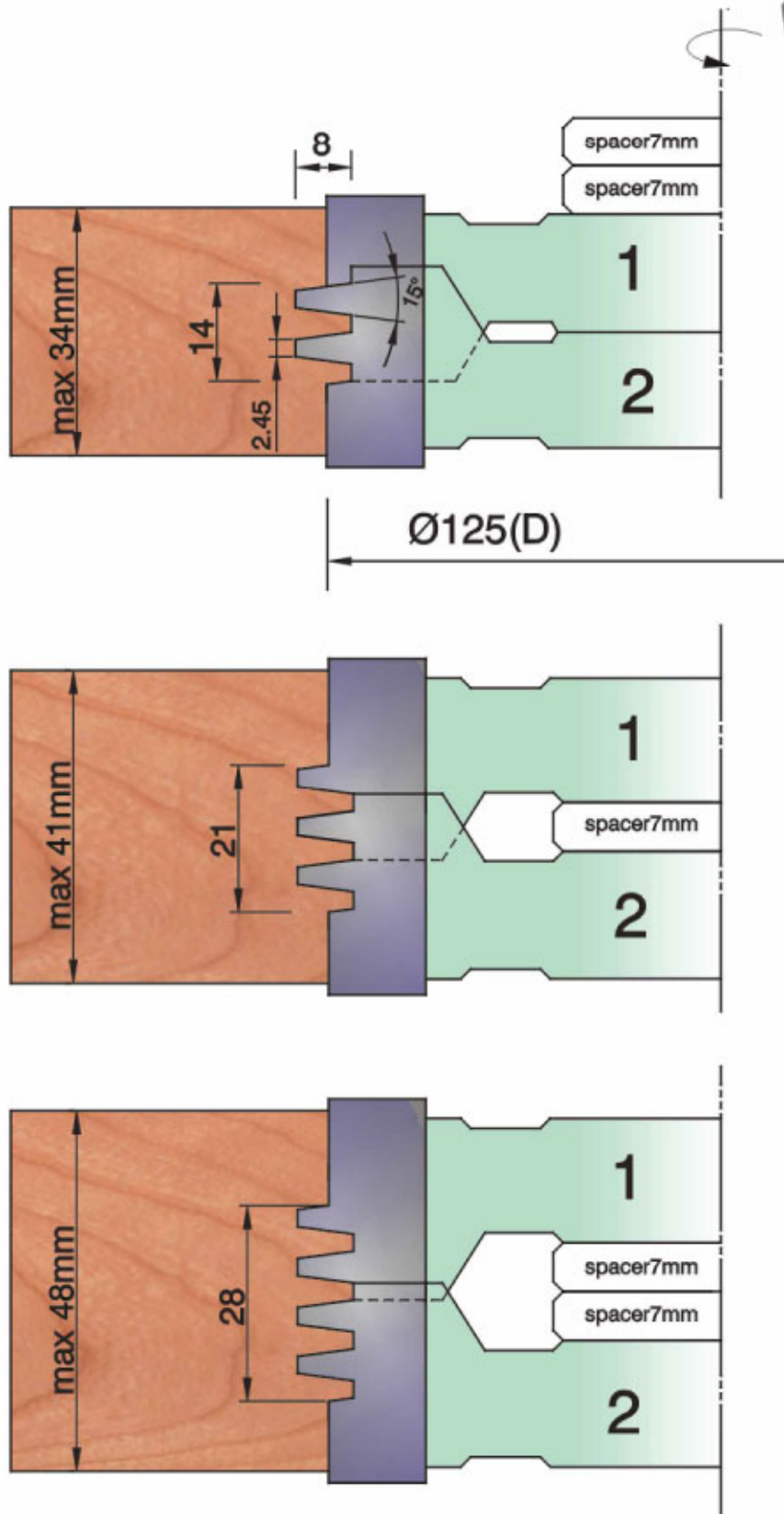

Carbide-Tipped V Type Glue Joint Shaper Cutters

(Brazed T.C.T thickness 4mm)



TF618A D125*W50*d40*Z4/Z6 1SET/2PCS

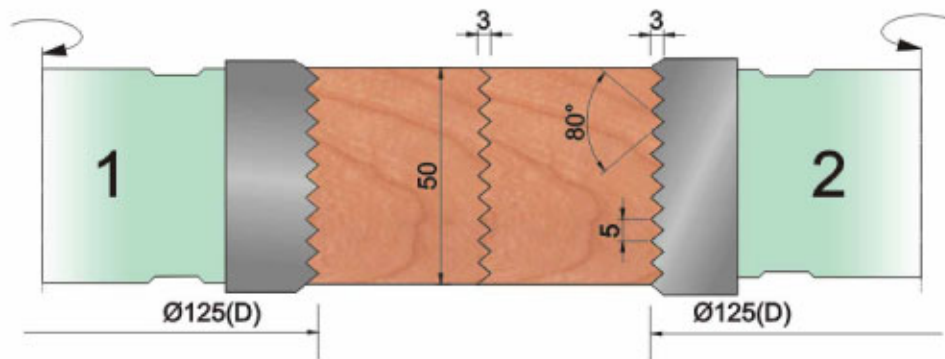

TF618B D125*W50*d40*Z4/Z6 1SET/2PCS

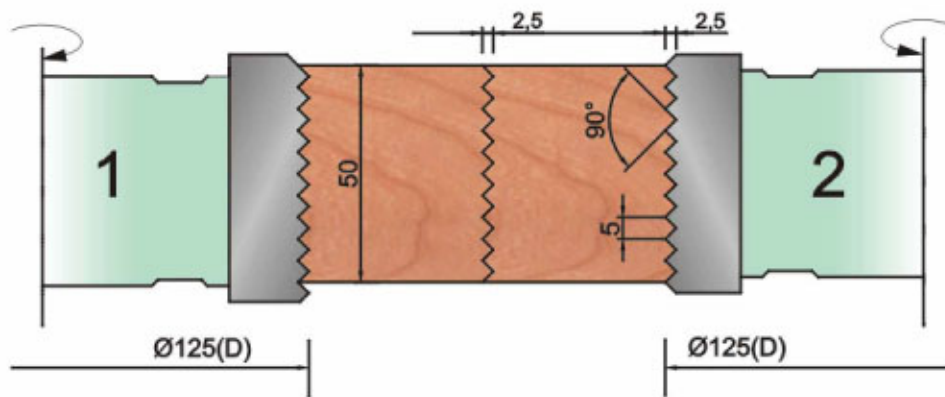

TF618C D125*W50*d40*Z4/Z6 1SET/2PCS

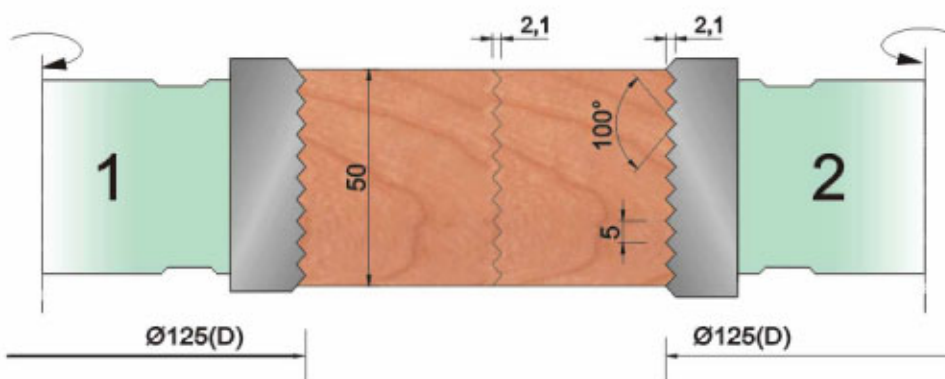

• Special specifications is available as per custom's order.

Carbide-Tipped V Type Glue Joint Shaper Cutters

(Brazed T.C.T thickness 4mm)



TF619A D125*W50*d40*Z4/Z6 1SET/2PCS

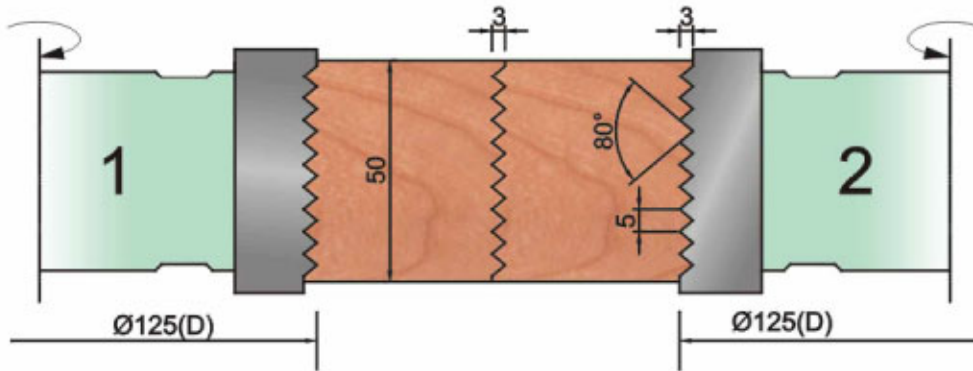

TF619B D125*W50*d40*Z4/Z6 1SET/2PCS

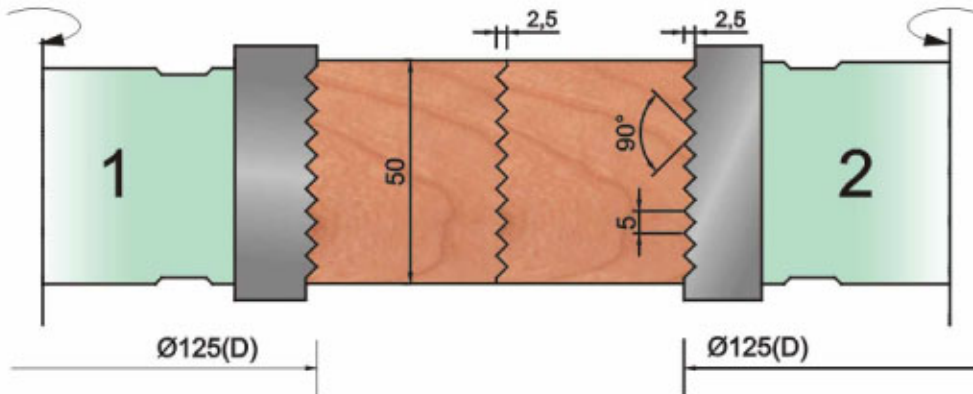

TF619C D125*W50*d40*Z4/Z6 1SET/2PCS

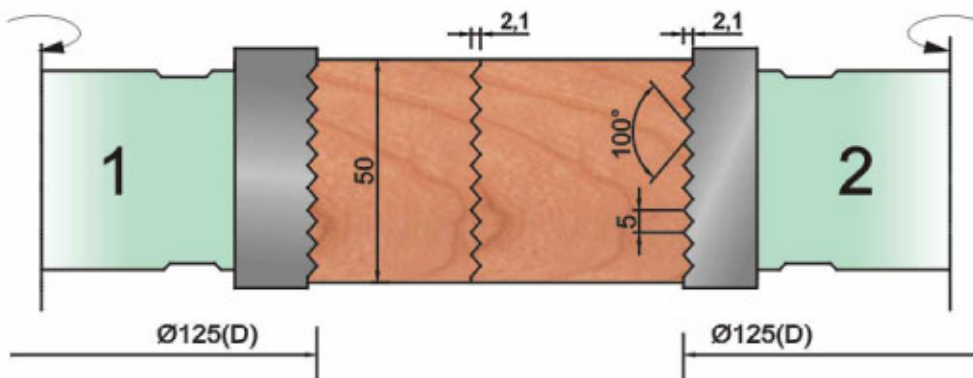

• Special specifications is available as per custom's order.

Carbide-Tipped Adjustable Corner Round Cutter Sets

(Brazed T.C.T thickness 4mm)



TF620A D125*W15~55mm*d40*Z4/Z6 1SET/4PCS

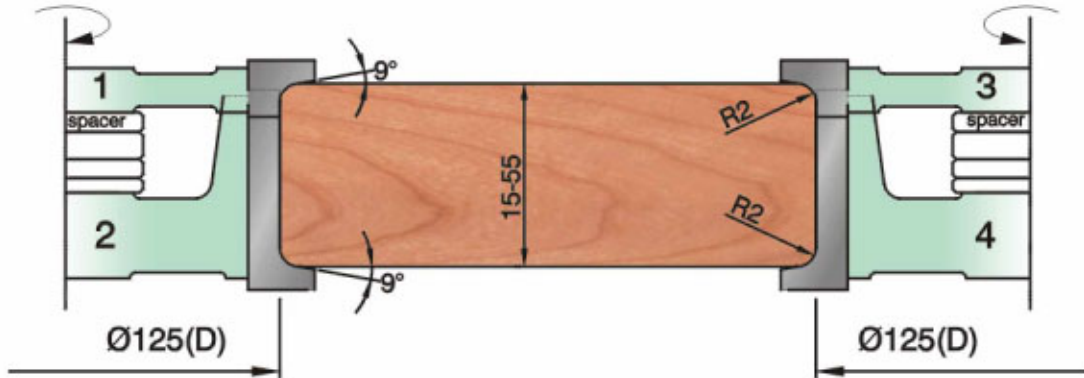

TF620B D125*W15~55mm*d40*Z4/Z6 1SET/4PCS

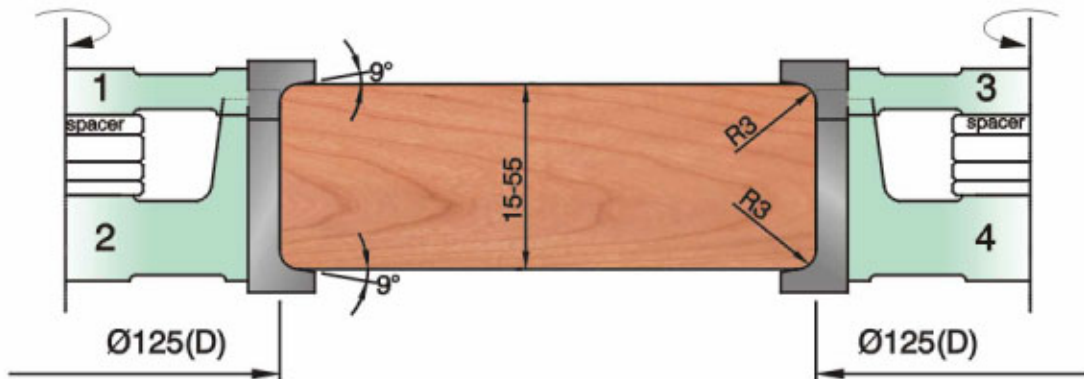

TF620C D125*W15~55mm*d40*Z4/Z6 1SET/4PCS

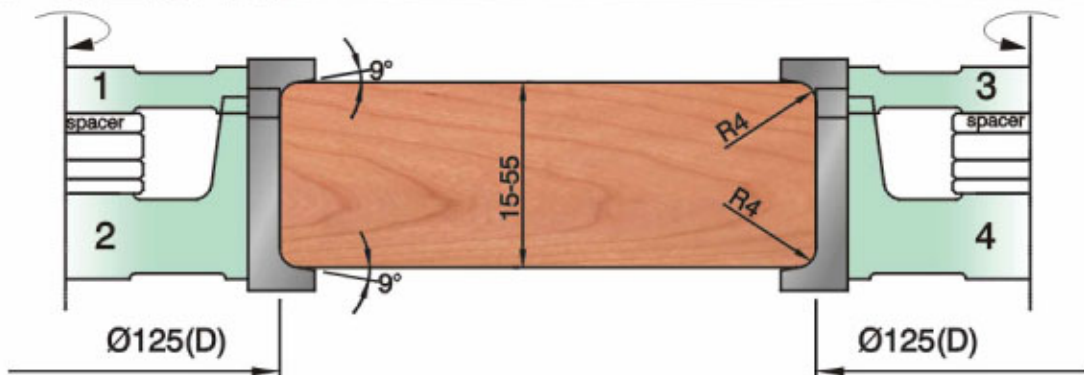

• Special specifications is available as per custom's order.

Carbide-Tipped Adjustable Corner Round Cutter Sets

(Brazed T.C.T thickness 4mm)



TF620D D125*W15~55mm*d40*d40*Z4/Z6 1SET/4PCS

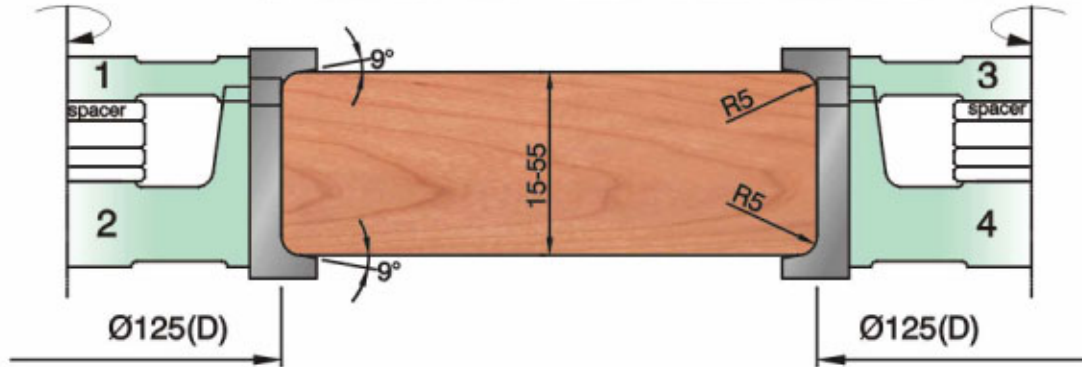

TF620E D125*W15~55mm*d40*d40*Z4/Z6 1SET/4PCS

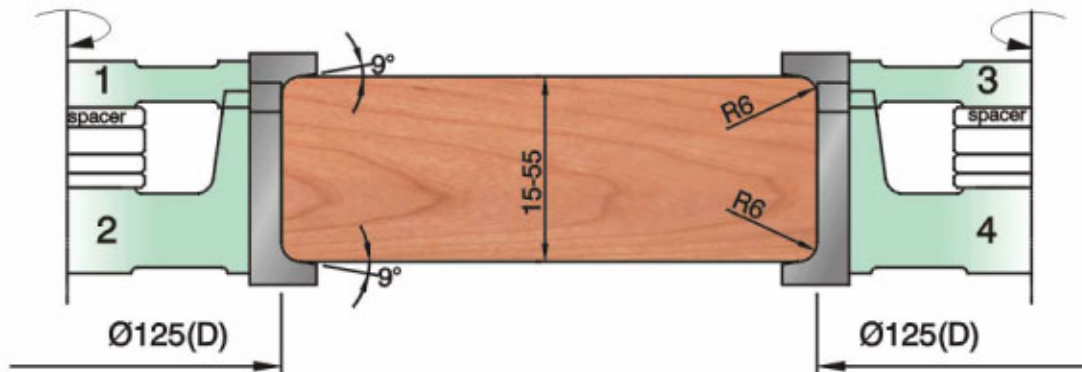

TF620F D125*W15~55mm*d40*d40*Z4/Z6 1SET/4PCS

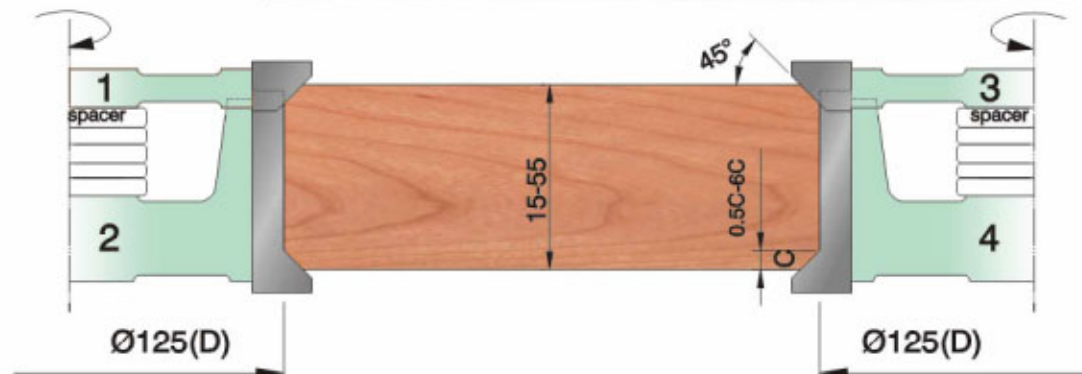

• Special specifications is available as per custom's order.

Carbide-Tipped Adjustable Corner Round Cutter Sets

(Brazed T.C.T thickness 4mm)



TF620G D125*W12~35mm*d40*Z4/Z6 1SET/4PCS

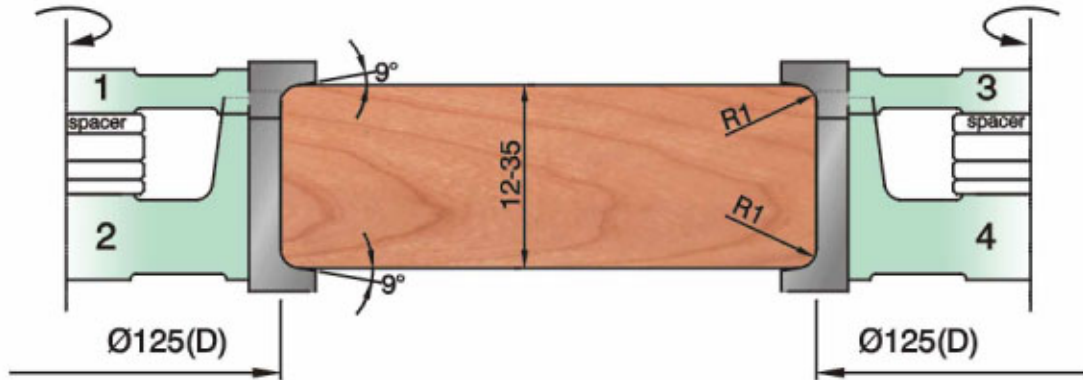

TF620H D125*W12~35mm*d40*Z4/Z6 1SET/4PCS

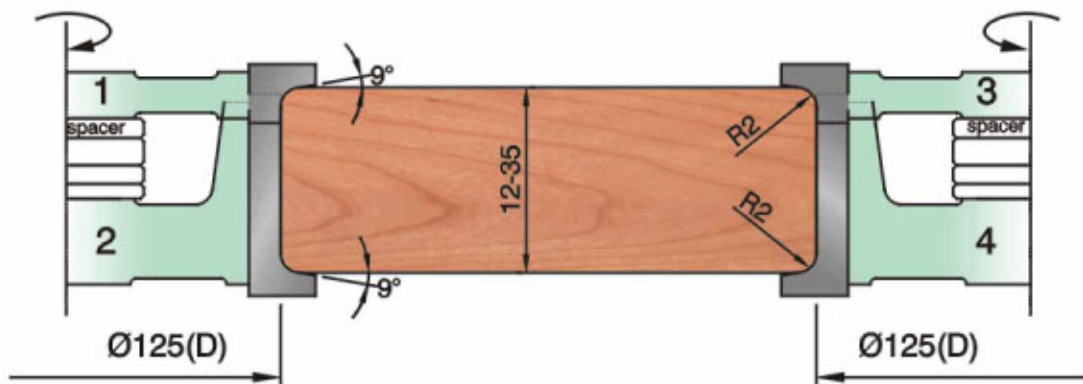

TF620J D125*W12~35mm*d40*Z4/Z6 1SET/4PCS

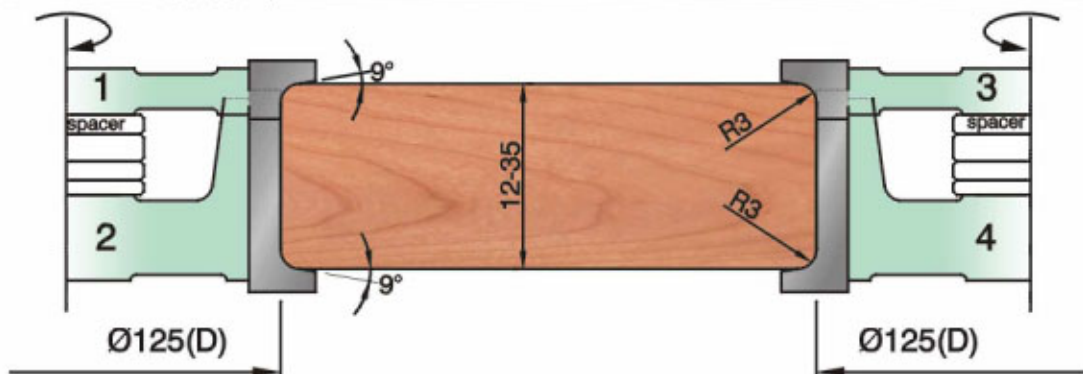

• Special specifications is available as per custom's order.

Carbide-Tipped Adjustable Corner Round Cutter Sets

(Brazed T.C.T thickness 4mm)



TF620K D125*W12~35mm*d40*Z4/Z6 1SET/4PCS

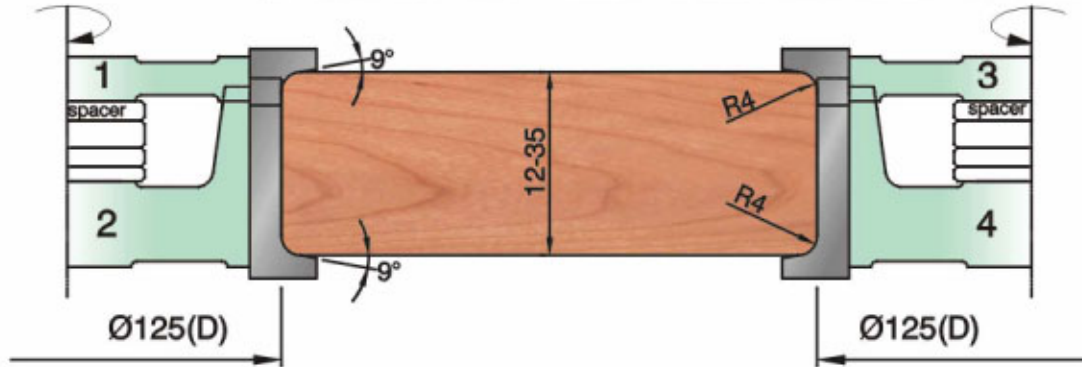

TF620L D125*W12~35mm*d40*Z4/Z6 1SET/4PCS

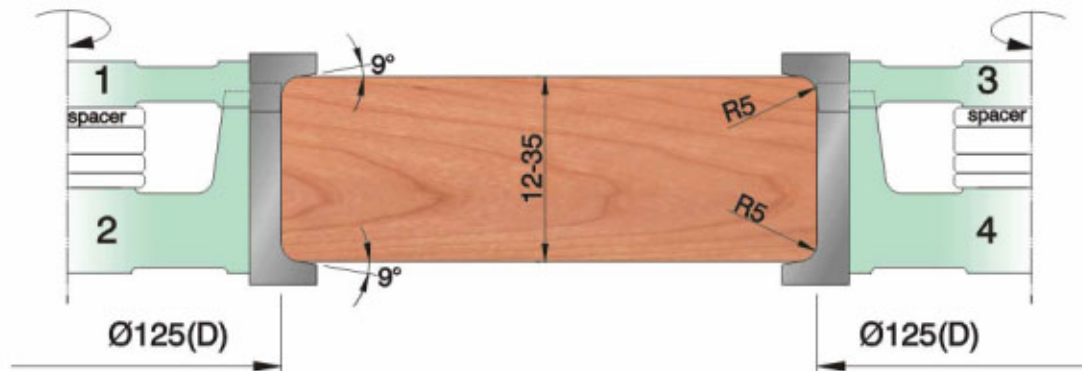

TF620M D125*W12~35mm*d40*Z4/Z6 1SET/4PCS

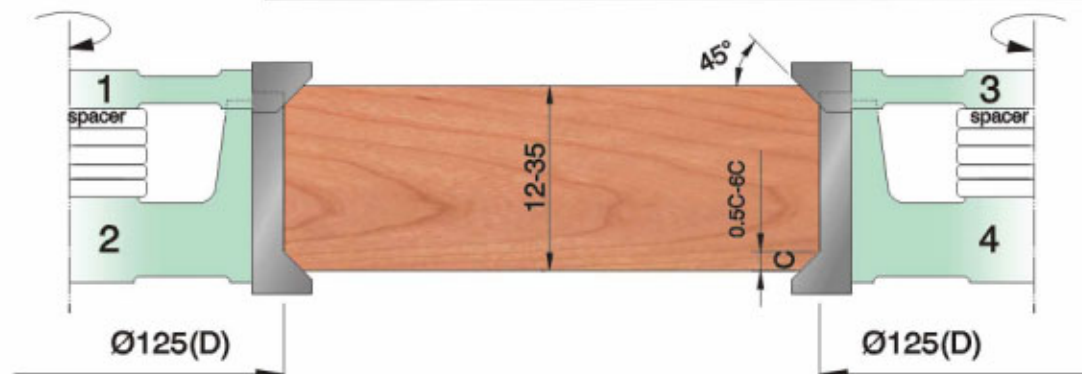

• Special specifications is available as per custom's order.

Carbide-Tipped Adjustable Corner Round & Chamfer 45Dg Cutter Sets

(Brazed T.C.T thickness 4mm)

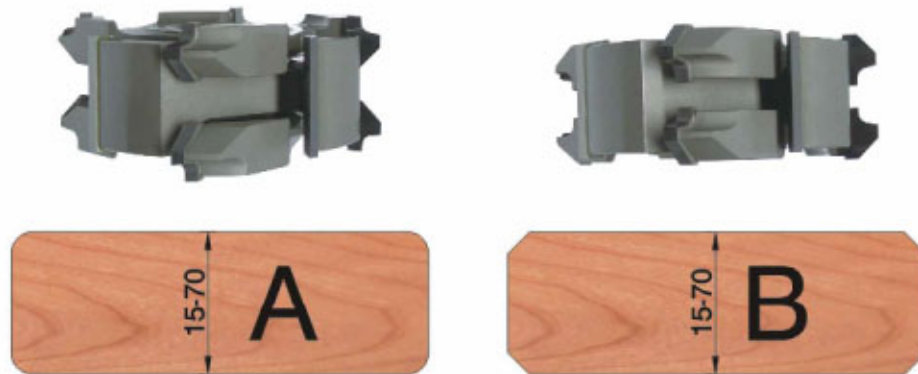

TF621R2C $D125*W15-70mm*d40*Z4$ 1SET/6PCS

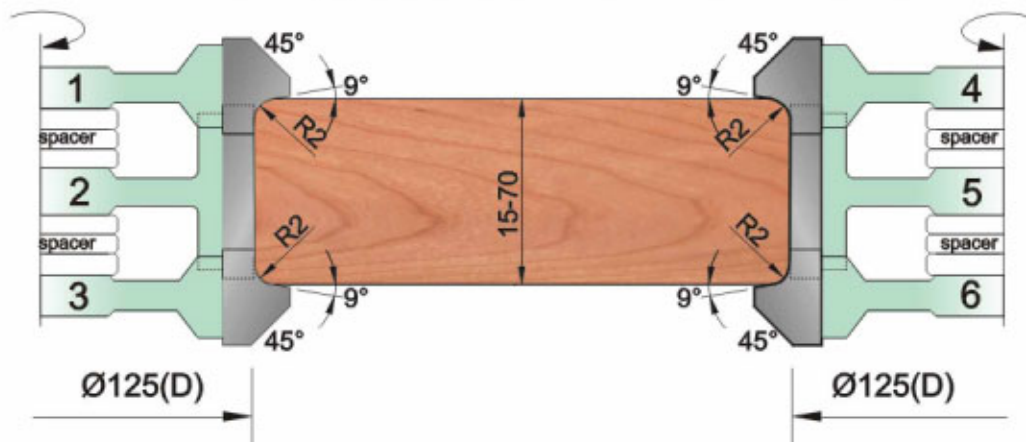

TF621R3C $D125*W15-70mm*d40*Z4$ 1SET/6PCS

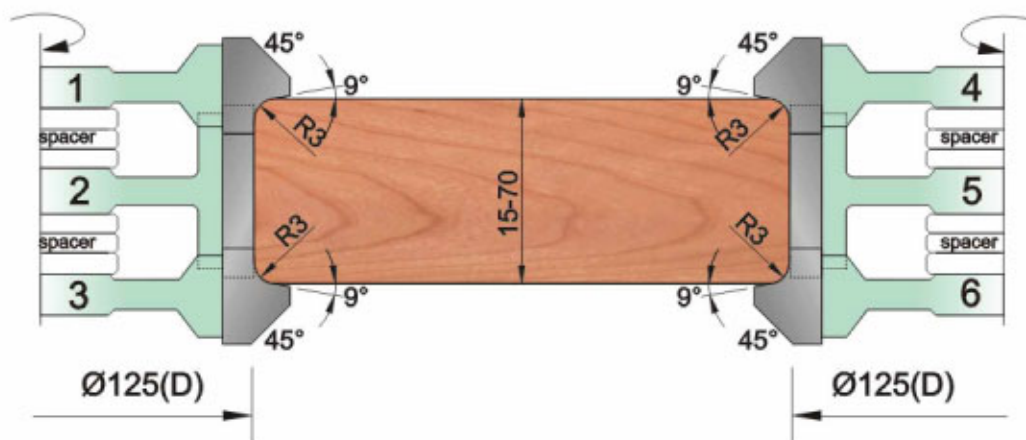

• Special specifications is available as per custom's order.

Carbide-Tipped Adjustable Corner Round & Chamfer 45Dg Cutter Sets

(Brazed T.C.T thickness 4mm)

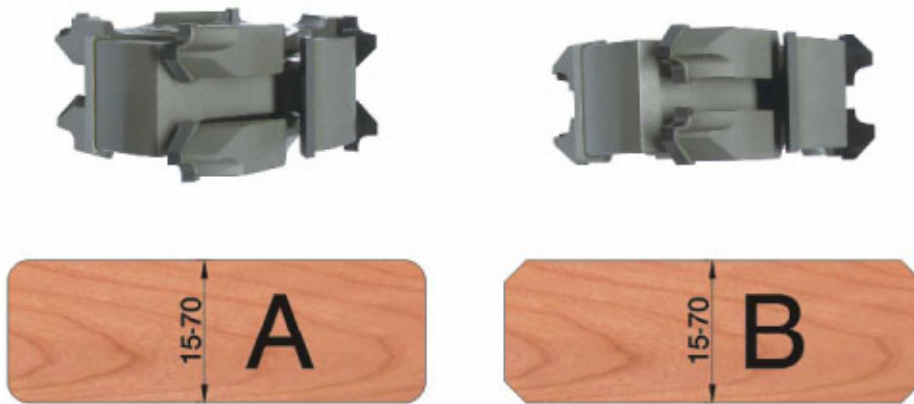

TF621R4C D125*W15-70mm*d40*Z4 1SET/6PCS

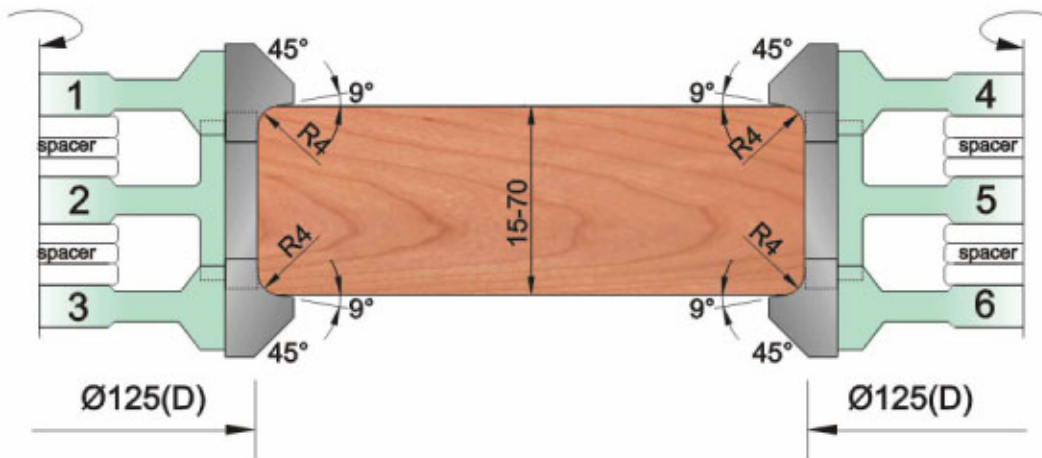

TF621R5C D125*W15-70mm*d40*Z4 1SET/6PCS

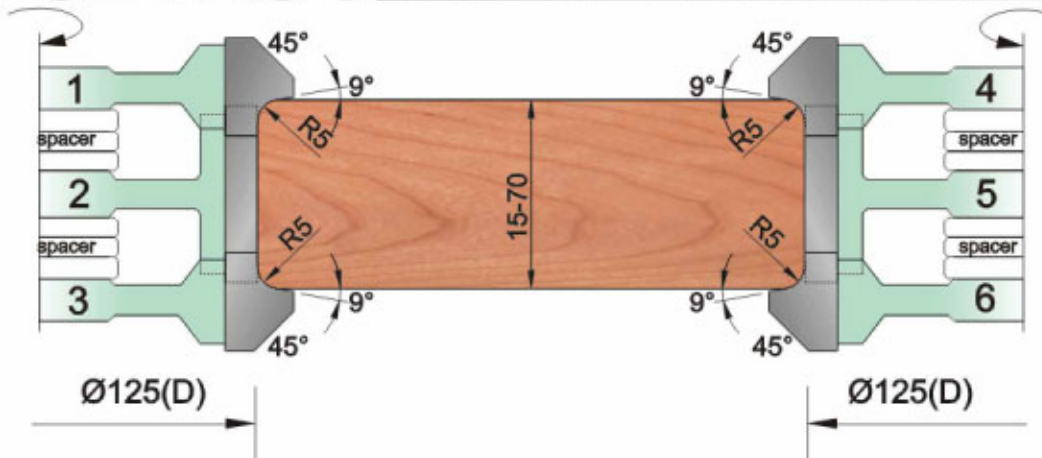

• Special specifications is available as per custom's order.

TF630 Carbide-Tipped Handrail Profile Cutter Sets

(Brazed T.C.T thickness 4mm)



D125*d40*Z4 1set/3pcs

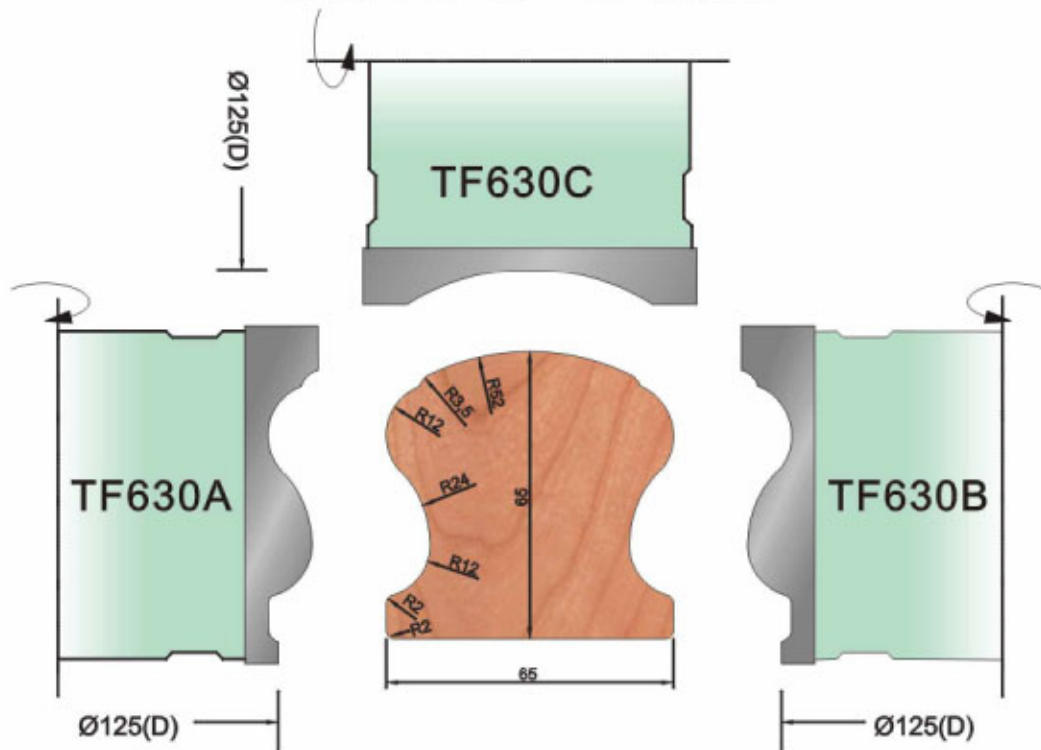

TF631 Handrail Profile Cutter Sets

D125xd40xZ4 1set/3pcs

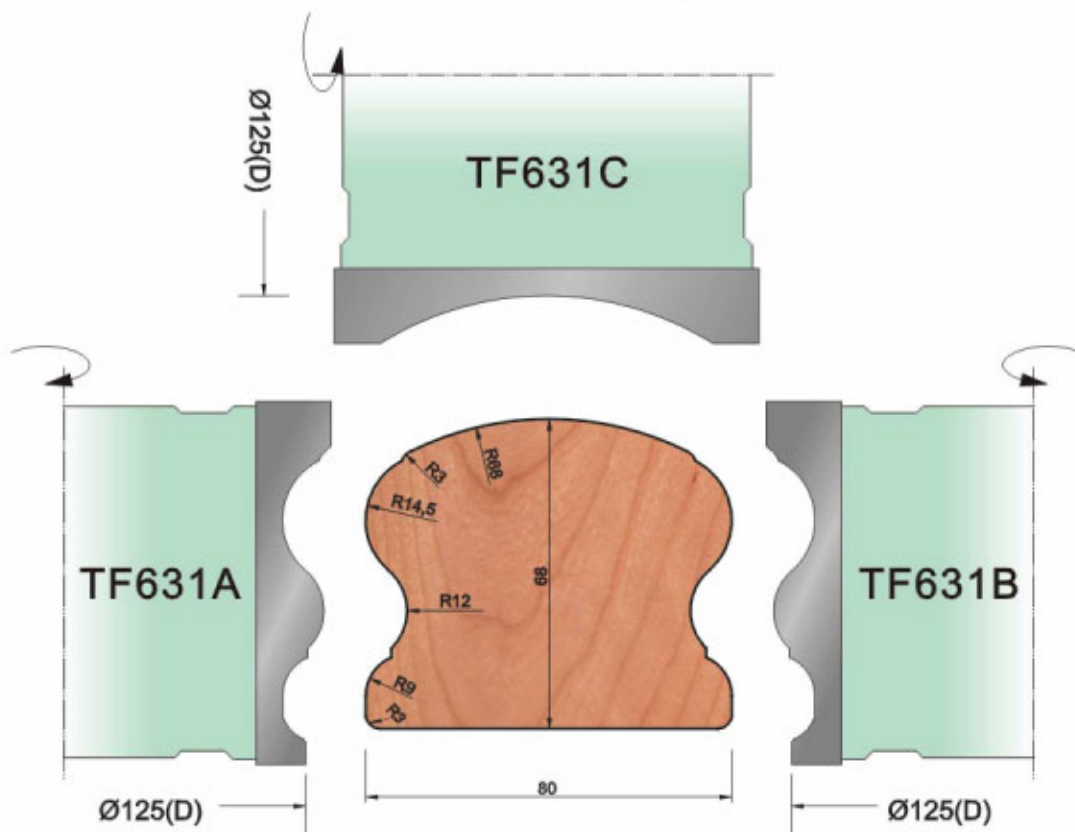

TF632 Carbide-Tipped Outdoor Antislip Flooring Profile Cutters

(Brazed T.C.T thickness 4mm)

TF632

Carbide-Tipped Outdoor Antislip Flooring Profile Cutters

D125*W20-30mm*d40*Z4 1SET/4PCS (A~D)

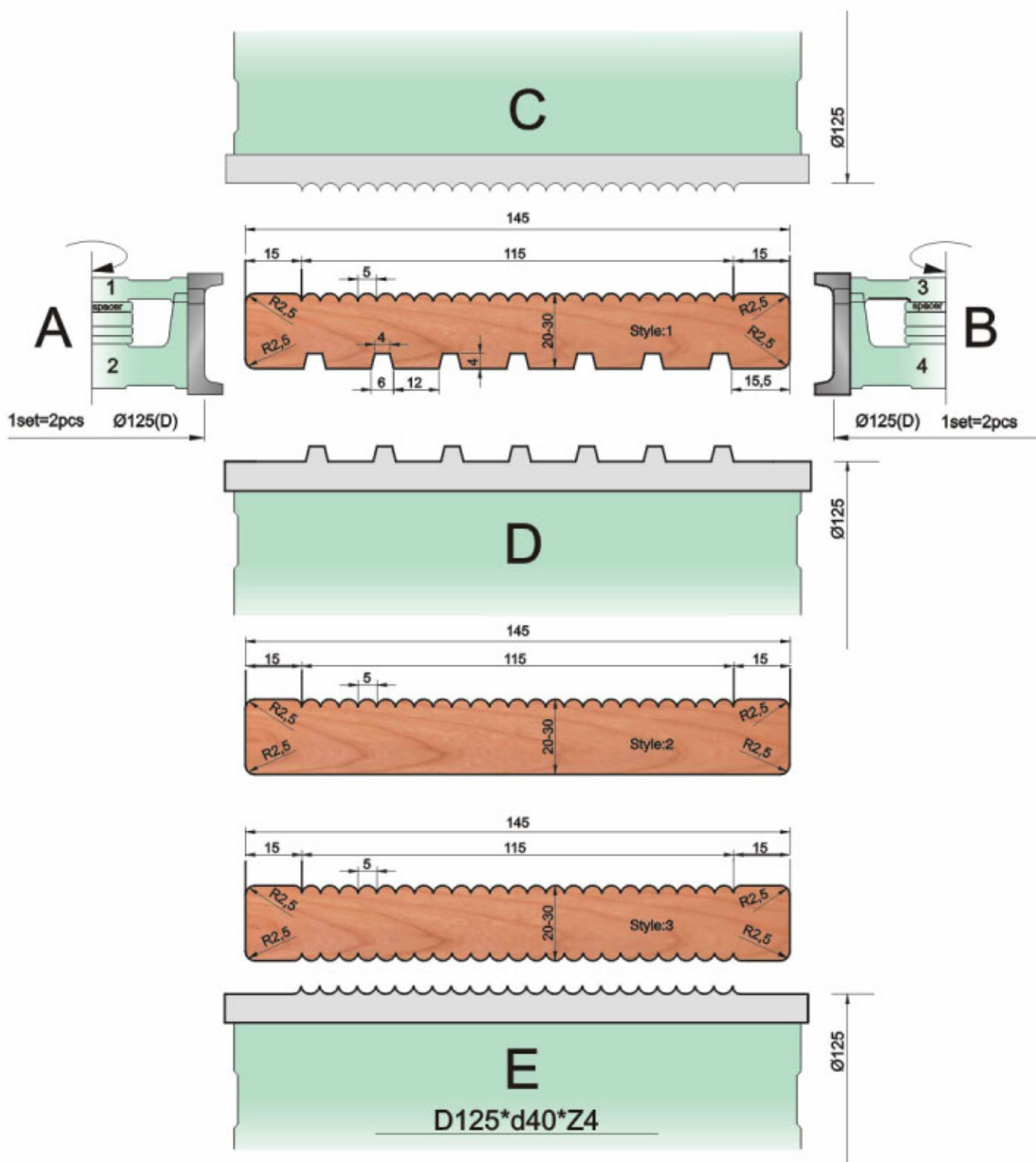

TF661

Carbide-Tipped Grooving Shaper Cutters

(Brazed T.C.T thickness 3mm)

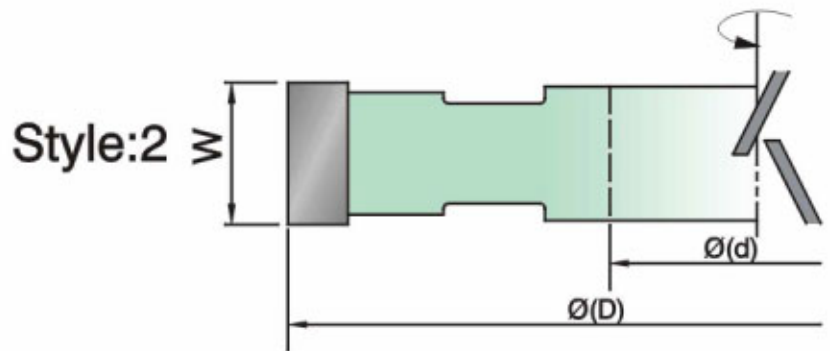
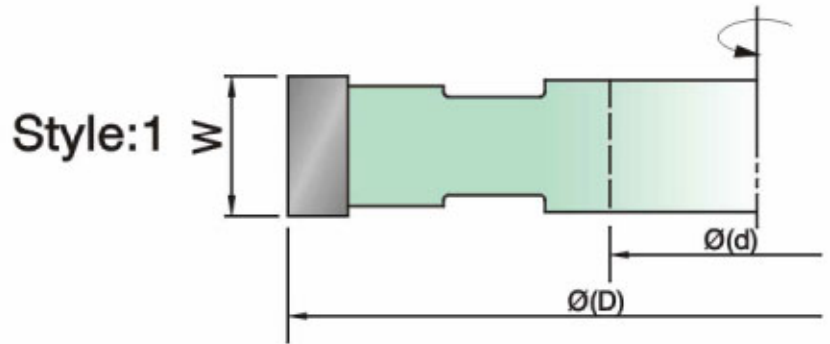
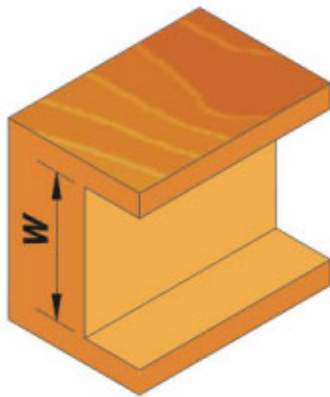

with alternating shear

• Special specifications is available as per custom's order.

ITEM No	Style	W mm	ϕ D mm	ϕ d mm	Z
TF661A		6	125	25.4/30/31.75/32/35/40/50	6
TF661B		8	125	25.4/30/31.75/32/35/40/50	6
TF661C		10	125	25.4/30/31.75/32/35/40/50	6
TF661D		12	125	25.4/30/31.75/32/35/40/50	6
TF661E		14	125	25.4/30/31.75/32/35/40/50	6
TF661F		16	125	25.4/30/31.75/32/35/40/50	6
TF661G		18	125	25.4/30/31.75/32/35/40/50	6
TF661H		20	125	25.4/30/31.75/32/35/40/50	6
TF661J		22	125	25.4/30/31.75/32/35/40/50	6
TF661K		24	125	25.4/30/31.75/32/35/40/50	6
TF661L		26	125	25.4/30/31.75/32/35/40/50	6
TF661M		28	125	25.4/30/31.75/32/35/40/50	6
TF661N		30	125	25.4/30/31.75/32/35/40/50	6
TF661P		32	125	25.4/30/31.75/32/35/40/50	6

TF662

Carbide-Tipped Grooving Shaper Cutters

(Brazed T.C.T thickness 3mm)

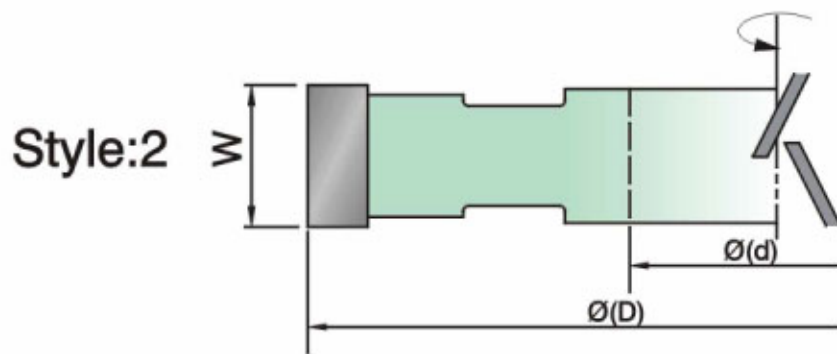
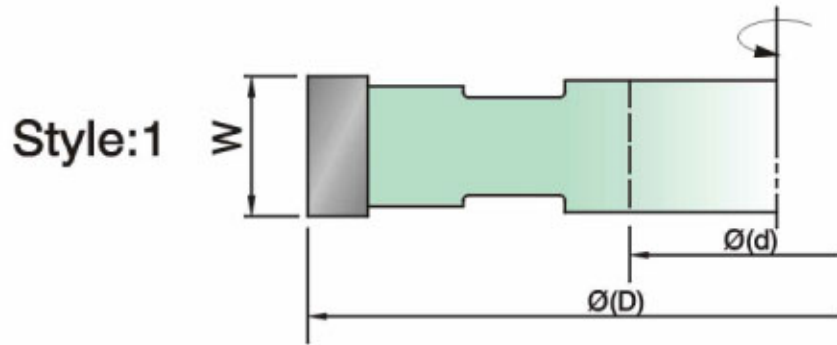
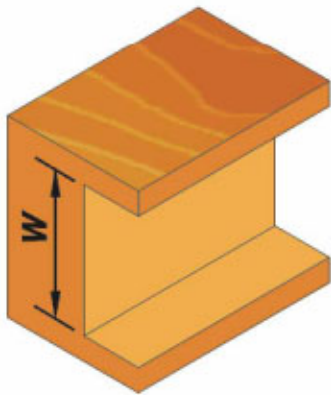

with alternating shear

• Special specifications is available as per custom's order.

ITEM No	Style	W mm	ϕD mm	ϕd mm	Z
TF662A		6	150	25.4/30/31.75/32/35/40/50	6
TF662B		8	150	25.4/30/31.75/32/35/40/50	6
TF662C		10	150	25.4/30/31.75/32/35/40/50	6
TF662D		12	150	25.4/30/31.75/32/35/40/50	6
TF662E		14	150	25.4/30/31.75/32/35/40/50	6
TF662F		16	150	25.4/30/31.75/32/35/40/50	6
TF662G		18	150	25.4/30/31.75/32/35/40/50	6
TF662H		20	150	25.4/30/31.75/32/35/40/50	6
TF662J		7	250	25.4/30/31.75/32/35/40/50	12
TF662K		9	250	25.4/30/31.75/32/35/40/50	12
TF662L		11	250	25.4/30/31.75/32/35/40/50	12
TF662M		13	250	25.4/30/31.75/32/35/40/50	12
TF662N		15	250	25.4/30/31.75/32/35/40/50	12
TF662P		17	250	25.4/30/31.75/32/35/40/50	12
TF662Q		19	250	25.4/30/31.75/32/35/40/50	12
TF662R		21	250	25.4/30/31.75/32/35/40/50	12

TF663

Carbide-Tipped Adjustable Grooving Shaper Cutters Sets

(Brazed T.C.T thickness 4mm)

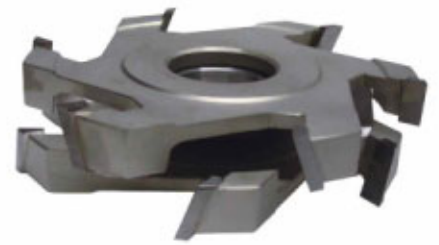

with alternating shear

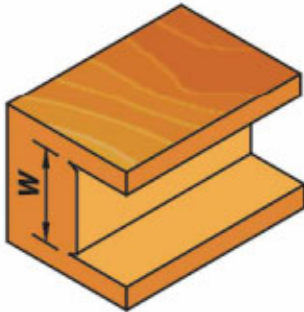

(with spurs)

Style:1

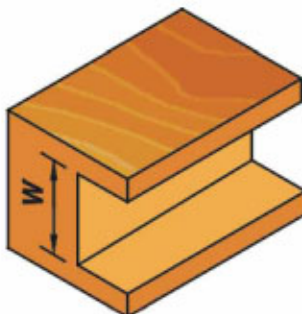
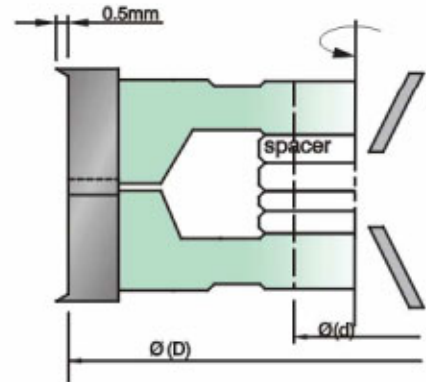

Style:2

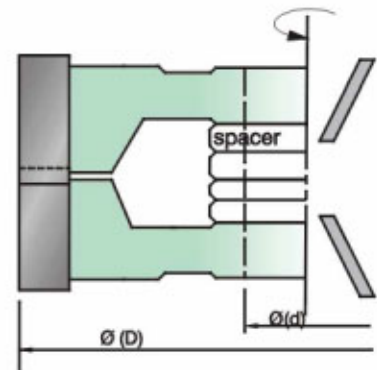

• Special specifications is available as per custom's order.

ITEM No	Style	W mm	ϕ D mm	ϕ d mm	Z
TF663A		5-8	150	25.4/30/31.75/32/35/40/50	6
TF663B		8-14	150	25.4/30/31.75/32/35/40/50	6
TF663C		14-26	150	25.4/30/31.75/32/35/40/50	6
TF663D		26-50	150	25.4/30/31.75/32/35/40/50	6
TF663E		50-98	150	25.4/30/31.75/32/35/40/50	6
TF663F		5-8	200	25.4/30/31.75/32/35/40/50	6
TF663G		8-14	200	25.4/30/31.75/32/35/40/50	6
TF663H		14-26	200	25.4/30/31.75/32/35/40/50	6
TF663J		26-50	200	25.4/30/31.75/32/35/40/50	6
TF663K		50-98	200	25.4/30/31.75/32/35/40/50	6

TF665

Carbide-Tipped Grooving Shaper Cutters (with scorers)

(Brazed T.C.T thickness 4mm)

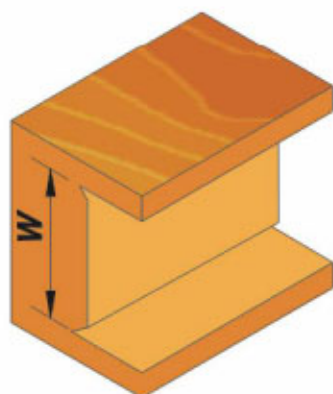

Style:1

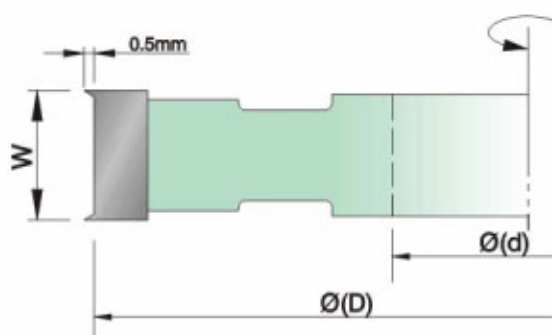

Style:2

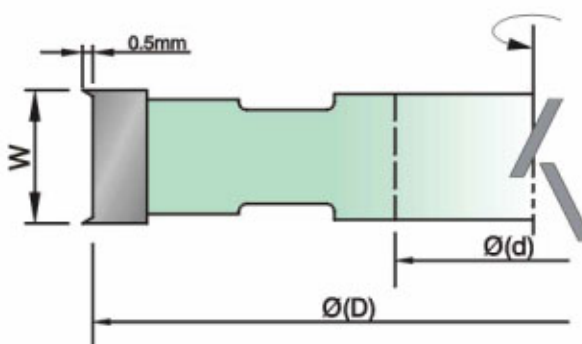

with alternating shear

• Special specifications is available as per custom's order.

ITEM No	Style	W mm	ϕ D mm	ϕ d mm	Z
TF665A		6	200	25.4/30/31.75/32/35/40/50	6
TF665B		8	200	25.4/30/31.75/32/35/40/50	6
TF665C		10	200	25.4/30/31.75/32/35/40/50	6
TF665D		12	200	25.4/30/31.75/32/35/40/50	6
TF665E		14	200	25.4/30/31.75/32/35/40/50	6
TF665F		16	200	25.4/30/31.75/32/35/40/50	6
TF665G		18	200	25.4/30/31.75/32/35/40/50	6
TF665H		20	200	25.4/30/31.75/32/35/40/50	6
TF665J		7	250	25.4/30/31.75/32/35/40/50	12
TF665K		9	250	25.4/30/31.75/32/35/40/50	12
TF665L		11	250	25.4/30/31.75/32/35/40/50	12
TF665M		13	250	25.4/30/31.75/32/35/40/50	12
TF665N		15	250	25.4/30/31.75/32/35/40/50	12
TF665P		17	250	25.4/30/31.75/32/35/40/50	12
TF665Q		19	250	25.4/30/31.75/32/35/40/50	12
TF665R		21	250	25.4/30/31.75/32/35/40/50	12

Carbide-Tipped Corner Round Shaper Cutters

TF666

(Brazed T.C.T thickness 4mm)



• Special specifications is available as per custom's order.

Style:1

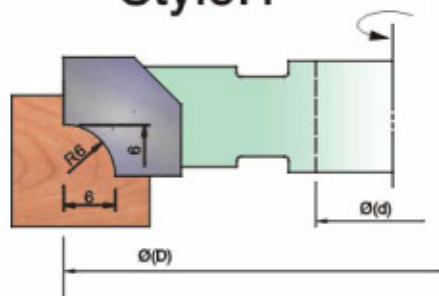

Style:3

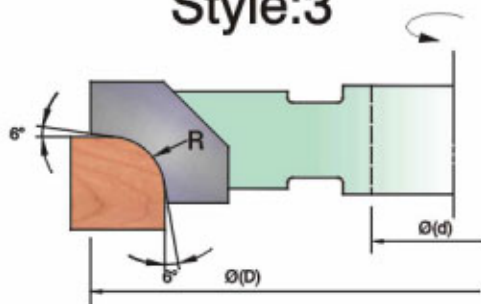

Style:2

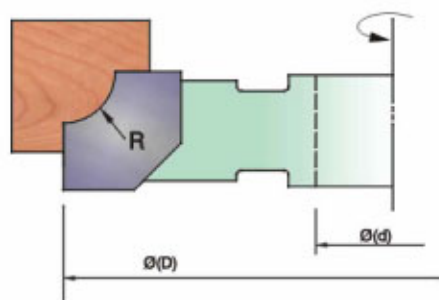

Style:4

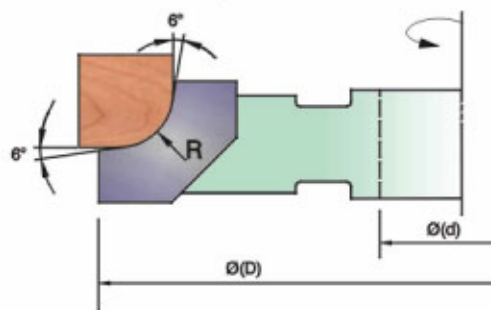

ITEM No.	Style	R mm	ϕ D mm	ϕ d mm	Z
TF666A		6	125	30/35/40	4
TF666B		8	125	30/35/40	4
TF666C		10	125	30/35/40	4
TF666D		12	125	30/35/40	4
TF666E		14	140	30/35/40	4
TF666F		16	140	30/35/40	4
TF666G		18	140	30/35/40	4
TF666H		20	150	30/35/40	4
TF666J		22	150	30/35/40	4
TF666K		25	150	30/35/40	4

Carbide-Tipped Half Round Shaper Cutters

TF667

(Brazed T.C.T thickness 4mm)

TF667 Carbide-Tipped Half Round Shaper Cutters

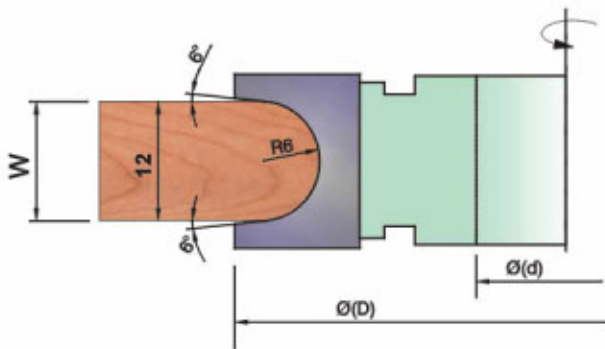

Style:1

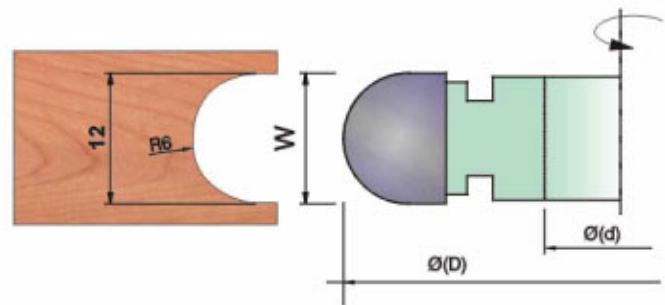

Style:2

• Special specifications is available as per custom's order.

Carbide-Tipped Half Round Shaper Cutters

ITEM No.	Style	R mm	W mm	ϕ D mm	ϕ d mm	Z
TF667A		6	12	125	25.4/30/31.75/40	4
TF667B		8	16	125	25.4/30/31.75/40	4
TF667C		10	20	125	25.4/30/31.75/40	4
TF667D		12	24	125	25.4/30/31.75/40	4
TF667E		14	28	140	25.4/30/31.75/40	4
TF667F		16	32	140	25.4/30/31.75/40	4
TF667G		18	36	140	25.4/30/31.75/40	4
TF667H		20	40	140	25.4/30/31.75/40	4
TF667J		22	44	150	25.4/30/31.75/40	4
TF667K		24	48	150	25.4/30/31.75/40	4

Mortising Chisel Sets

TF983



Mortising Chisel Sets

SIZE inch	mm
1/4"	6.0
5/16"	8.0
3/8"	9.5
7/16"	11.0
1/2"	12.7
9/16"	14.3
5/8"	15.9
3/4"	18.0
	21.0
1"	25.0
	30.0

TF983

Mortising Chisel Sets

TF984 Straight Bits

Steel Body With Solid Carbide Stick Mounted



• Custom designs available.

ITEM No	D mm	L mm	C mm
TF984D3	3	15	12
TF984D4	4	15	12
TF984D5	5	20	12
TF984D6	6	20	12
TF984D8	8	20	12

TF985 Straight Bits

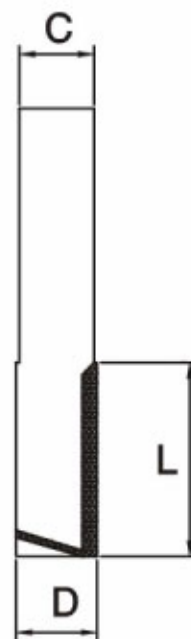

• Custom designs available.

ITEM No	D mm	L mm	C mm
TF985D8	8	25	12
TF985D10	10	25	12
TF985D12	12	25	12
TF985D14	14	25	12
TF985D16	16	30	12
TF985D18	18	30	12
TF985D20	20	30	12

TF986

Planer Knives-High Speed Steel (HSS)

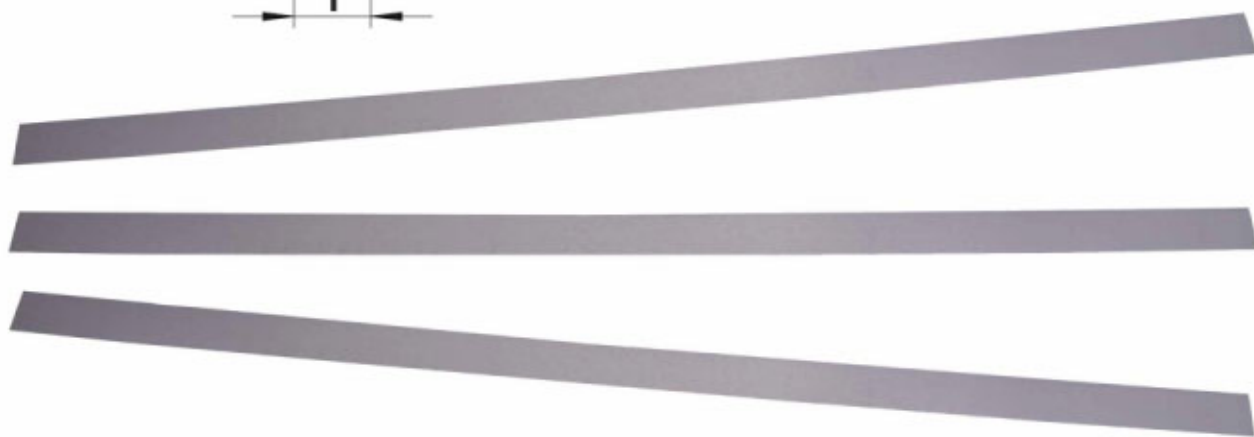
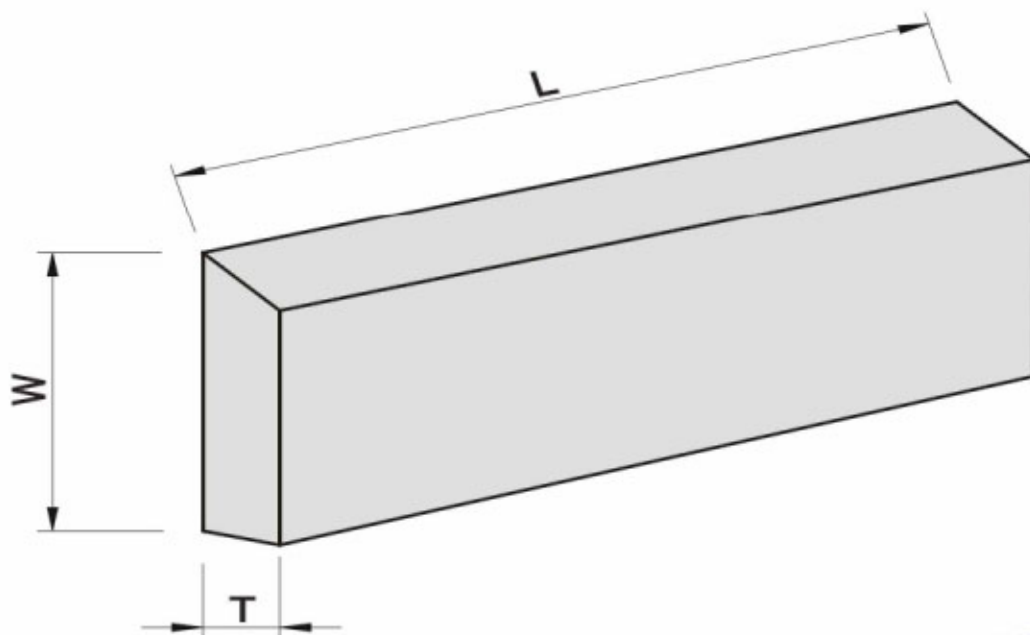

Planer Knives-High Speed Steel (HSS)			
ITEM No.	L mm	W mm	T mm
TF986A	260	30	3
TF986B	310	30	3
TF986C	350	30	3
TF986D	410	30	3
TF986E	510	30	3
TF986F	610	30	3
TF986G	610	38(HSS Inlay)	6

TF987

Planer Knives-Carbide-Tipped

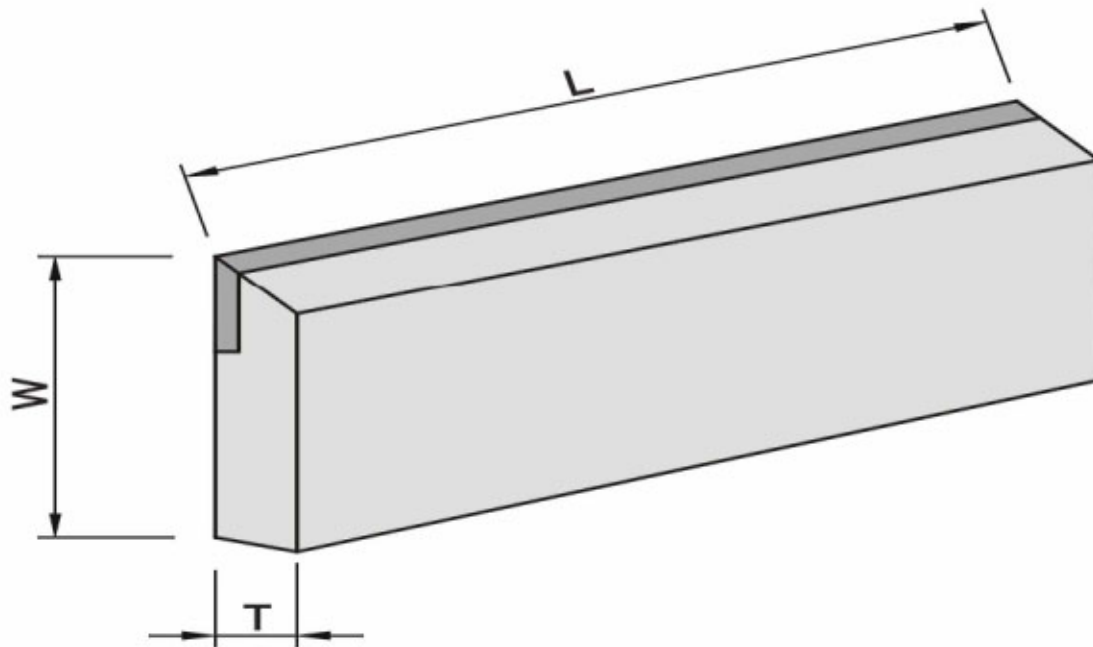

Planer Knives-Carbide-Tipped			
ITEM No.	L mm	W mm	T mm
TF987A	260	30	3
TF987B	310	30	3
TF987C	350	30	3
TF987D	410	30	3
TF987E	510	30	3
TF987F	610	30	3
TF987G	610	38	6

TF988

Corrugated Back Knives

-High Speed Steel (HSS)

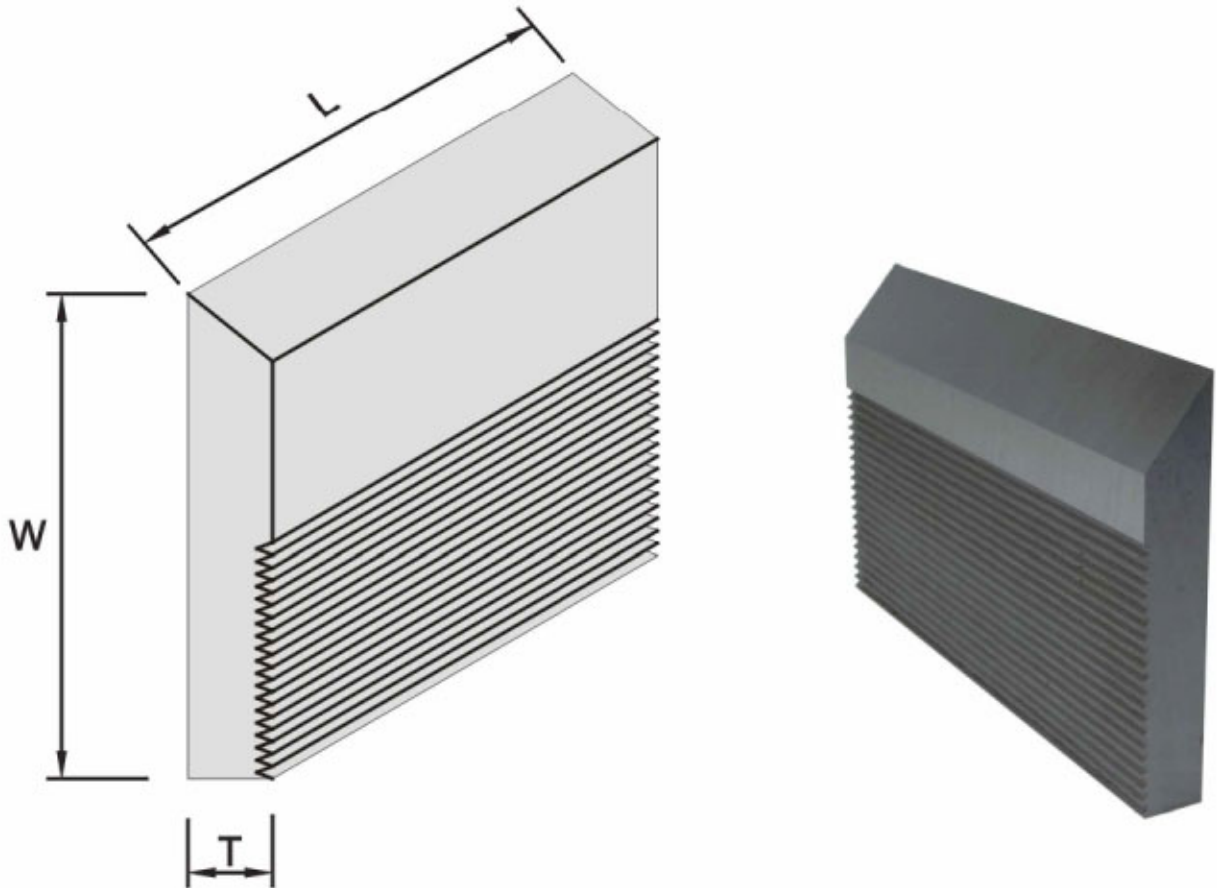

Corrugated Back Knives-High Speed Steel (HSS)

ITEM No.	L mm	W mm	T mm
TF988A	635	50	8
TF988B	635	60	8
TF988C	635	70	8

Woodworking Drill Bits

TF-SH311-B

Straight Shank Combination 2-Step Drills

High Speed Steel Spiral Flute

※D1/D2 Custom sizes are available

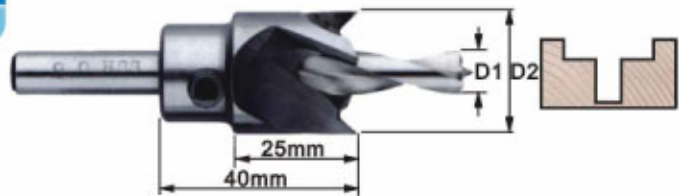

TF-H311-LB

Straight Shank Solid Mortising Tool

High Speed Steel Spiral Flute

※D1/D2 Custom sizes are available

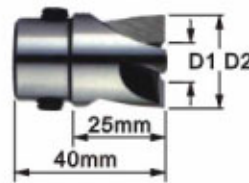

TF-RC125/150

Threaded Integral Adapter

- L. H. or R. H.
- RC125 Threading : M8x1.25
- RC150 Threading : M10x1.5
- Bore Dia : 10mm
- Insert Depth : 21mm



TF-TCT510

Tungsten Carbide Steel Tipped Drills(DOWEL)

- Spiral Flute : L.H. or R.H.Cut
- Shank Dia : 10mm
- Overall Length : 57/70mm
- Drill Dia : 5/6/8/9/10/12mm

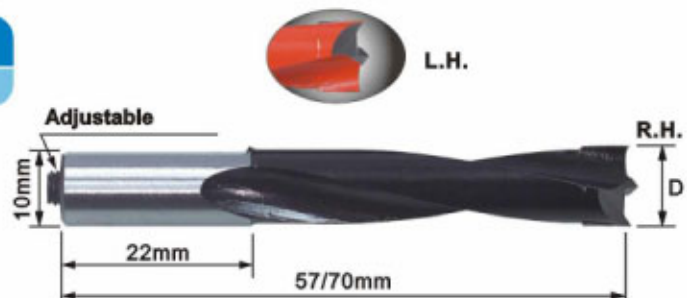

TF-TCT510-V

Tungsten Carbide Steel Tipped Drills(THRU-HOLE)

- Spiral Flute : L.H. or R.H.Cut
- Shank Dia : 10mm
- Overall Length : 57/70mm
- Drill Dia : 5/6/8/9/10/12mm

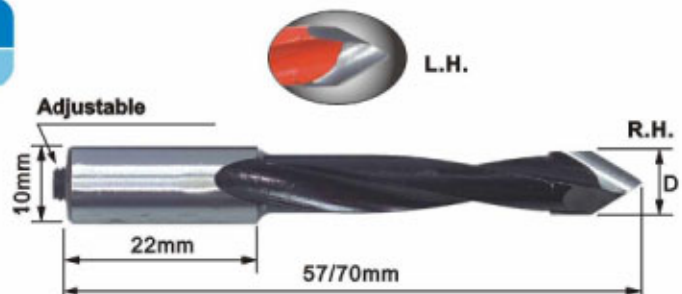

TF-TCT510-1

Tungsten Carbide Steel Tipped Drills(SPECIAL TCT)

- High Speed Steel Spiral Flute : L.H. or R.H.Cut
- Shank Dia : 10mm
- Overall Length : 57/70mm
- Drill Dia : 15/20/25/30/35mm



Woodworking Drill Bits

TF-A210

Threaded Shank Solid Drills

- High Speed Steel Spiral Flute : L.H. or R.H. Cut
- Threaded : M8x1.25
- Overall Length : 100mm
- Flute Length : 66mm
- Drill Dia: 5~16mm



TF-A210-1

Threaded Shank Solid Drills

- High Speed Steel Spiral Flute : L.H. or R.H. Cut
- Threaded : M10x1.5
- Overall Length : 100mm
- Flute Length : 66mm
- Drill Dia: 5~18mm

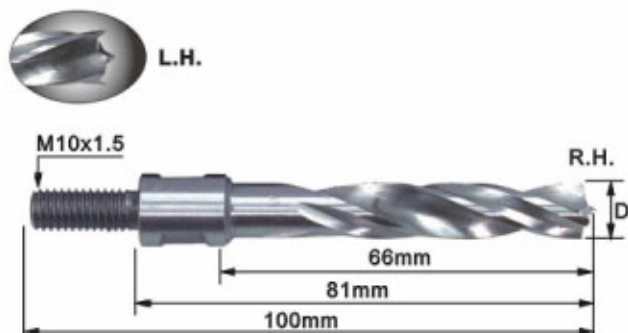

TF-RS210

Threaded Shank Solid Drills With Integral Adapter (Newly economic type)

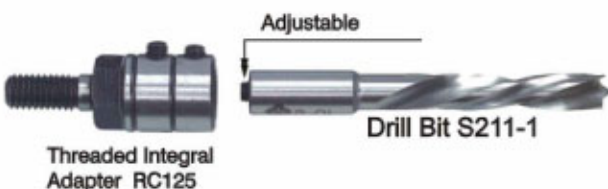

TF-A210-L/V

Threaded Shank Solid Step Drills

- High Speed Steel Spiral Flute: L. H. or R. H. Cut • Flute Length: 66 mm
 - Overall Length: 100 mm
 - Threading: M8x1.25/ M10x1.5
- ※Customized step drill diameter and flute length are available upon request.

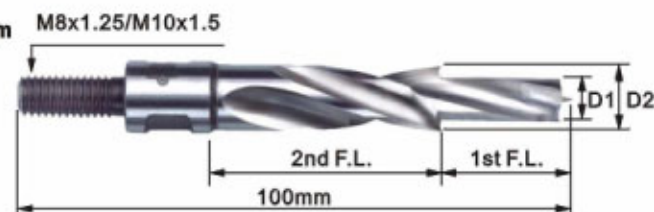

TF-K112-2T/ 3T /4T

Straight Shank Solid Mortising Tool

K112-2T

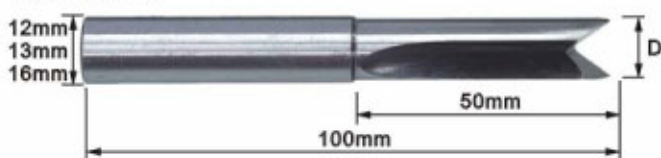

- Shank Dia: 12/ 13/ 16 mm
- Drill Dia: 6~16 mm
- Overall Length: 100 mm



K112-3T

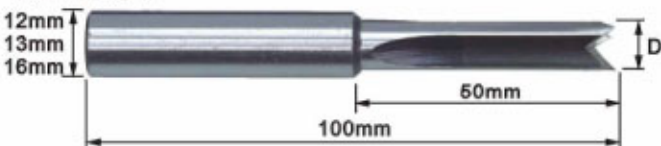

K112-4T



Woodworking Drill Bits

TF-H211-L / V

Straight Shank Solid Mortising Tool

- High Speed Steel Spiral Flute
- Flute Length : 25/40/50/60/70/80mm
- Shank Dia : 10mm
- Overall Length : 55/70/80/90/100/110mm
- D1 : 3/4/4.5/5 mm
- D2 : 8/9/9.5/10/12mm

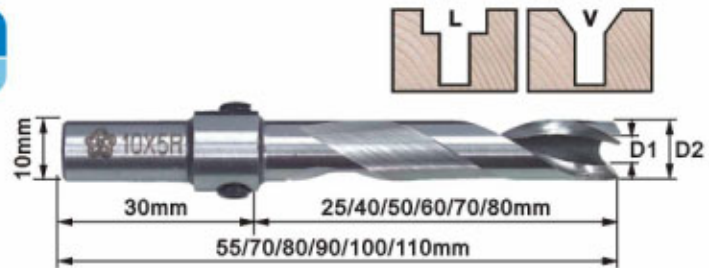

TF-AH211-L / V

Threaded Straight Shank Solid Mortising Tool

- High Speed Steel Spiral Flute
- Flute Length : 40/50mm
- Threaded : M8*1.25/M10*1.5
- Overall Length : 80/90mm
- D1 : 3/4/4.5/5 mm
- D2 : 8/9/9.5/10/12mm

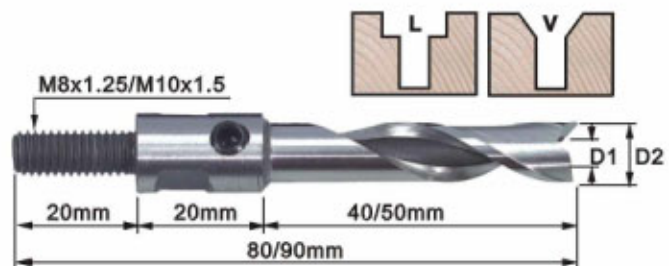

TF-S211-4T

Straight Shank Solid Drills

- High Speed Steel Four Spiral Flute
- Overall Length : 90/100mm
- Flute Length : 60/70mm
- Drill Dia: 5~18mm
- Shank Dia : 10mm

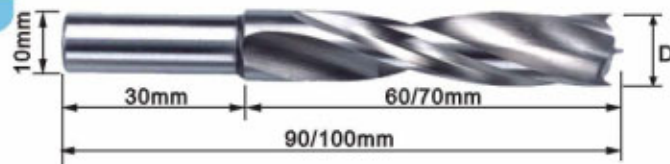

TF-S211-2T

- High Speed Steel Two Spiral Flute
- Shank Dia. & Drill Dia. : 4/4.5/5/6 mm

TF-S211-BL / BV

Straight Shank Solid Step Drills

- High Speed Steel Spiral Flute
- Shank Dia : 10/12 mm
- ※ Customized step drill diameter and flute length are available upon request.

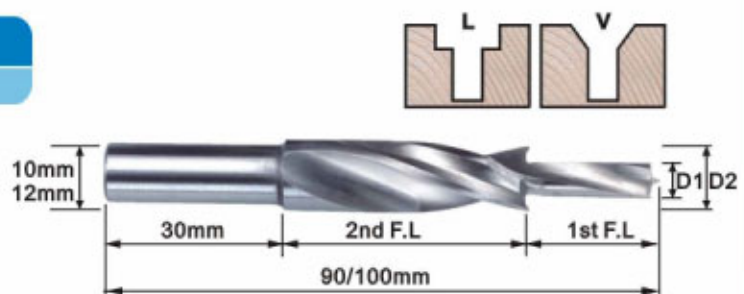

TF-S211-1

Adjustable Straight Shank Solid Drills

- High Speed Steel Spiral Flute : L.H. or R.H. Cut
- Shank Dia : 10mm
- Flute Length : 53mm
- Overall Length : 75mm
- Drill Dia: 5~18mm

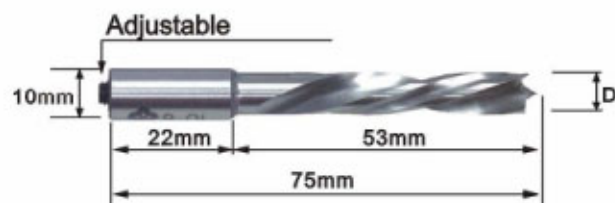

TF989 Carbide-Tipped Circular Saw Blades

- Special specifications is available as per custom's order
- For cutting wood.MDF.aluminum.acrylic.

For Cross Cut			
ϕ D mm	Thickness mm	ϕ d mm	Z
205	3.0	25.4/30	60
205	3.0	25.4/30	80
255	3.0	25.4/30	80
255	3.0	25.4/30	100
255	3.0	25.4/30	120
305	3.0	25.4/30	100
305	3.0	25.4/30	120
355	3.0	25.4/30	80
355	3.0	25.4/30	100
355	3.2	25.4/30	120
405	3.2	25.4/30	120
455	3.4	25.4/30	120
505	3.4	25.4/30	100
505	3.4	25.4/30	120
610	4.0	25.4/30	120

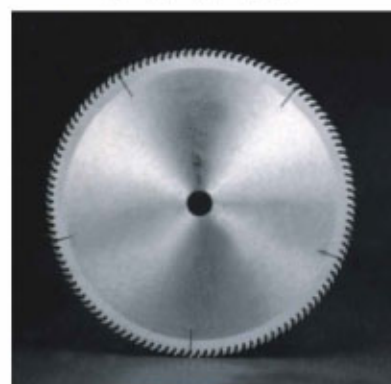
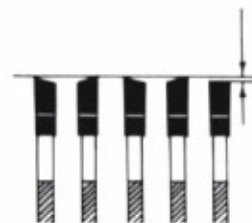

TF990 Circular Saw Blades

General Purpose Saw Blade			
ϕ D mm	Thickness mm	ϕ d mm	Z
150	3.0	30	24
180	3.0	30	24
205	3.0	30	24
255	3.0	30	30
305	3.2	30	36
355	3.2	30	36
405	3.2	30	24
405	3.2	30	48
455	3.4	30	30
505	4.0	30	30

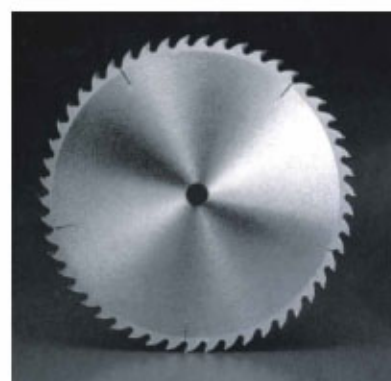
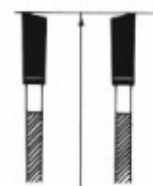

TF991 Carbide-Tipped Circular Saw Blades

• Special specifications is available as per custom's order

For Rip And Multiple Rip Saw			
ϕ D mm	Thickness mm	ϕ d mm	Z
255	2.2	50/70	30
255	2.6	50/70	30
255	3.0	50/70	30
305	2.6	50/70	36
305	3.0	50/70	36
305	3.2	50/70	36
355	3.2	50/70	36
355	3.4	50/70	36
405	3.4	50/70	30

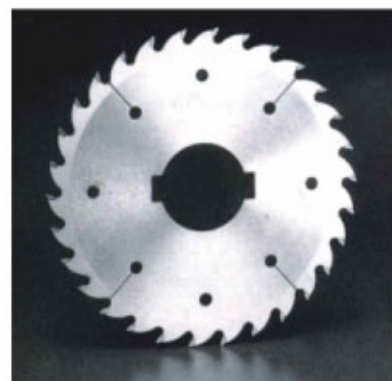

TF992 Circular Saw Blades

For Rip Saw with wing				
ϕ D mm	Thickness mm	ϕ d mm	Z	wing
305	3.0	70	30	2
305	3.0	70	30	4
305	3.0	70	36	4
355	3.2	70	28	4
355	3.2	70	36	4
355	4.0	70	30	4
405	3.4	70	30	4
405	4.0	70	36	4
455	4.0	70	28	4



TF993 Spacers / Rings / Shims

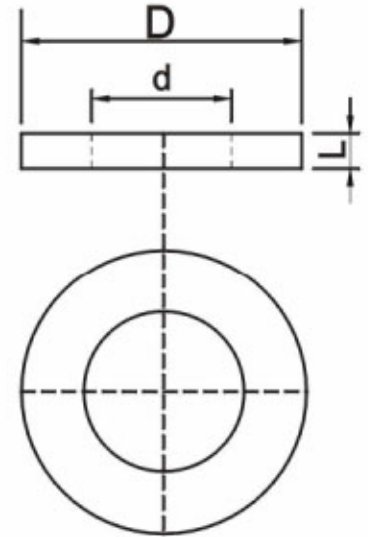
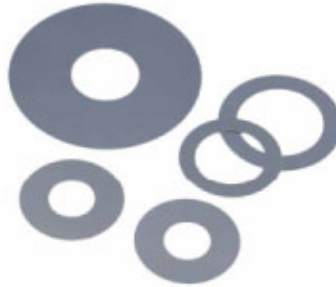

D (mm)	L (mm)	d (mm)
60	0.1	25.4
60	0.2	25.4
60	0.3	25.4
60	0.5	25.4
60	1.0	25.4
60	3.0	25.4
60	5.0	25.4
60	10.0	25.4
60	15.0	25.4
60	20.0	25.4
60	0.1	30
60	0.2	30
60	0.3	30
60	0.5	30
60	1.0	30
60	3.0	30
60	5.0	30
60	10.0	30
60	15.0	30
60	20.0	30

D (mm)	L (mm)	d (mm)
60	0.1	31.75
60	0.2	31.75
60	0.3	31.75
60	0.5	31.75
60	1.0	31.75
60	3.0	31.75
60	5.0	31.75
60	10.0	31.75
60	15.0	31.75
60	20.0	31.75
60	0.1	35
60	0.2	35
60	0.3	35
60	0.5	35
60	1.0	35
60	3.0	35
60	5.0	35
60	10.0	35
60	15.0	35
60	20.0	35

D (mm)	L (mm)	d (mm)
60	0.1	40
60	0.2	40
60	0.3	40
60	0.5	40
60	1.0	40
60	3.0	40
60	5.0	40
60	10.0	40
60	15.0	40
60	20.0	40
70	0.1	50
70	0.2	50
70	0.3	50
70	0.5	50
70	1.0	50
70	3.0	50
70	5.0	50
70	10.0	50
70	15.0	50
70	20.0	50

TF995

T-Bushings For Shaper Cutters

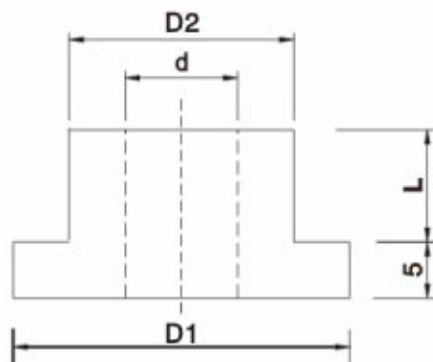

D1 (mm)	D2 (mm)	L (mm)	d (mm)
58	30	10	25.4
58	30	15	25.4
58	30	20	25.4
58	30	25	25.4
58	31.75	10	25.4
58	31.75	15	25.4
58	31.75	20	25.4
58	31.75	25	25.4
58	35	10	25.4
58	35	15	25.4
58	35	20	25.4
58	35	25	25.4
58	35	10	30
58	35	15	30
58	35	20	30
58	35	25	30
58	35	10	31.75
58	35	15	31.75
58	35	20	31.75
58	35	25	31.75
58	40	10	25.4
58	40	15	25.4
58	40	20	25.4
58	40	25	25.4

D1 (mm)	D2 (mm)	L (mm)	d (mm)
58	40	10	30
58	40	15	30
58	40	20	30
58	40	25	30
58	40	10	31.75
58	40	15	31.75
58	40	20	31.75
58	40	25	31.75
58	40	10	35
58	40	15	35
58	40	20	35
58	40	25	35
68	50	10	25.4
68	50	15	25.4
68	50	20	25.4
68	50	25	25.4
68	50	10	30
68	50	15	30
68	50	20	30
68	50	25	30
68	50	10	40
68	50	15	40
68	50	20	40
68	50	25	40

TF996

Diamond Grinding Wheels

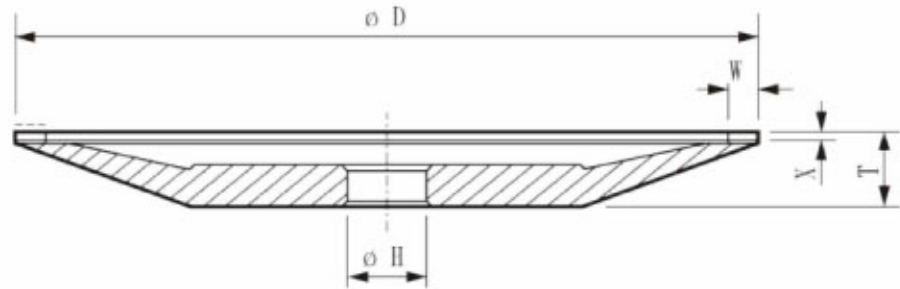

SDC 500
Bakelite



SDC 500
Bakelite

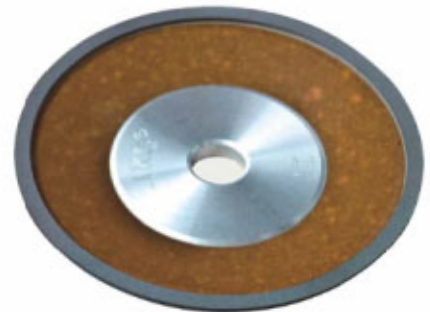





Diamond Grinding Wheels

Model	ϕD	W	X	T	H
SDC 500x2	150mm	6mm	2mm	15mm	16/20mm
SDC 500x3	150mm	10mm	3mm	15mm	16/20mm

TF997

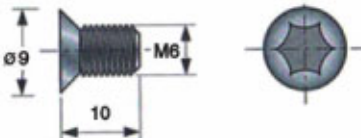
Insert Shaper Cutter Replacement Parts, Accessories

Item No.		
M615RH12	Ratchet Screwdriver	
M615T2030	Screwdriver Bits	
M615T2050	Screwdriver Bits	
4.5 X 100	Screwdriver	
5 X 150	Screwdriver	
6 X 150	Screwdriver	
M6 X 10	Screw	
M6 X 15	Screw	
M8 X 20	Screw	
M10 X 20	Screw	
M10 X 25	Screw	
M12 X 30	Screw	

TF998 Carbide-Tipped Finger Joint Shaper Cutters

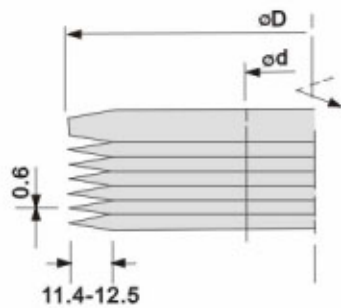
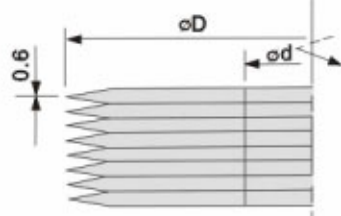
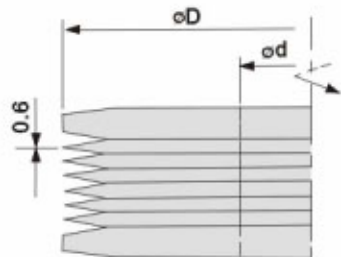
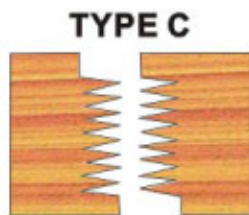
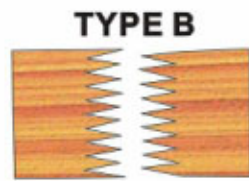
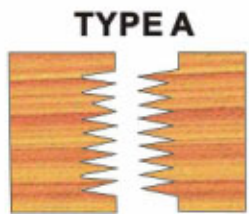

Finger Joint Shaper Cutters

ITEM No.	ϕ D mm	W mm	ϕ d mm	Z
TF998A	160	3.7	50	2
TF998B	160	3.7	70	2
TF998C	160	4.0	50	2
TF998D	160	4.0	70	2
TF998E	160	9.0	50	2
TF998F	160	9.0	70	2
TF998G	160	4.0	50	4
TF998H	160	4.0	70	4
TF998J	160	9.0	50	4
TF998K	160	9.0	70	4

TF999

Solid Carbide Replacement Knives

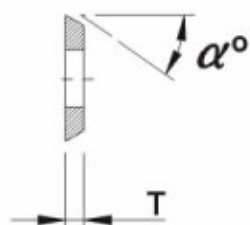

ITEM No.	L mm	W mm	T mm	C mm	α°
TF999A	L12	L12	1.5	—	35
TF999B	L14	L14	2.0	—	30
TF999C	L14	L14	2.0	—	37
TF999D	L14.6	L14.6	2.5	—	30
TF999E	L15	L15	2.5	—	30
TF999F	L15	L15	2.5	—	37
TF999G	L15	L15	2.5	R150	30
TF999H	L15	L12	1.5	—	35
TF999J	L20	L12	1.5	—	35
TF999K	L30	L12	1.5	14	35
TF999L	L30	L12	2.5	14	35
TF999M	L50	L12	1.5	26	35
TF999N	L60	L12	1.5	26	35

