

QUALITY

EFFICIENCY

SERVICE



**The Touch of
Sublimity**

滾筒式平面塗裝機 ROLLER COATER

- YL-W20 -T
- YL-W30 -T
- YL-W40 -T

特性

- 本機適用於平面塗裝。經本機處理過的工件，表面光滑、無色差。
- 每個滾輪應用獨立的變頻器做電子控制，產品品質可利用均佈滾筒的速度及壓力做調整可將漆完美的塗在工件上。
- 獨家鳩尾槽支撐系統的應用頭。
- 利用具有自動皮帶定位系統的皮帶輪運送工件。
- 清潔刀片具有外部的靠近及分離控制（不必升起保護柵欄）。
- 具有快速更換滾輪系統。
- 氣動雙隔膜泵浦，不產生火花，安全更不會有空氣污染之慮。
- 電動升降裝置與限動開關保護膠輪超厚斷電停止。
- 此機器可與加長型輸送機共用。

FEATURES

- This machine is applied for flat coating, providing workpieces of smooth finishing and consistent color.
- Each roller is independently controlled by a frequency inverter. The smoothing roller speed and pressure are adjustable, ensuring perfect coating on workpiece.
- The application head is supported by the exclusively designed dovetailed support system.
- Workpiece is fed through a conveyor belt that features automatic positioning.
- Cleaning scrapers can be conveniently controlled from outside without need to raise the grid guard.
- Rollers are easy to replace.
- Double air diaphragm pump does not create sparks, while ensuring operational safety and is air-pollution-free.
- The powered elevation design combined with limit switch provides over-travel protection. In case over-travel occurs, power shuts off automatically.
- The machine is available to operate with an extra large infeed roller conveyor.

適用

以UV底、UV面、PU、NC、水性塗料塗裝地板/傢俱/木片/玻璃/壁板/地磚/合板...等平面塗裝之使用。

APPLICATIONS

Flat coating with UV base / surface, PU, NC and water-based lacquer for floor / furniture / wood slice / glass / wall plane / tile / plywood and so on.

SPECIFICATIONS

型號	Model	YL-W20-T	YL-W30-T	YL-W40-T	YL-W50-T
最大塗裝寬度	Maximun width of coating	610 mm	920 mm	1290 mm	1650 mm
最短塗裝長度	Minimun length of coating	300 mm	300 mm	300 mm	300 mm
工件厚度	Workpiece thickness range	2-80 mm	2-80 mm	2-80 mm	2-80 mm
輸送帶速度	Conveyor belt speed	10-20M/min 其它速度可依客戶指定 Other speeds are available			
◎ 塗佈輪尺寸(mm)	Coating roller sizes (mm)	Ø205x780	Ø250x1100	Ø250x1450	Ø250x1800
◎ 均佈輪尺寸(mm)	Smoothing roller sizes (mm)	Ø150x780	Ø175x1100	Ø175x1450	Ø175x1800
◎ 塗佈輪馬力	Coating roller motor	0.75 KW	1.5 KW	1.5 KW	1.5 KW
◎ 均佈輪馬力	Smoothing roller motor	0.18 KW	0.37 KW	0.37 KW	0.75 KW
輸送帶馬力	Conveyor belt motor	0.75 KW	1.5 KW	1.5 KW	1.5 KW
昇降馬力	Elevation motor	0.18 KW	0.18 KW	0.18 KW	0.37 KW
泵浦(氣壓式隔膜泵浦)	Pump (air diaphragm pump)	3 / 8"	1 / 2"	1 / 2"	3 / 4"

規格、尺寸、外型及顏色若有變更恕不另通知。 Specifications, dimensions, appearance and color are subject to change without prior notice. 可依客戶需求定製特殊規格。 Customization is available to meet special process requirements.

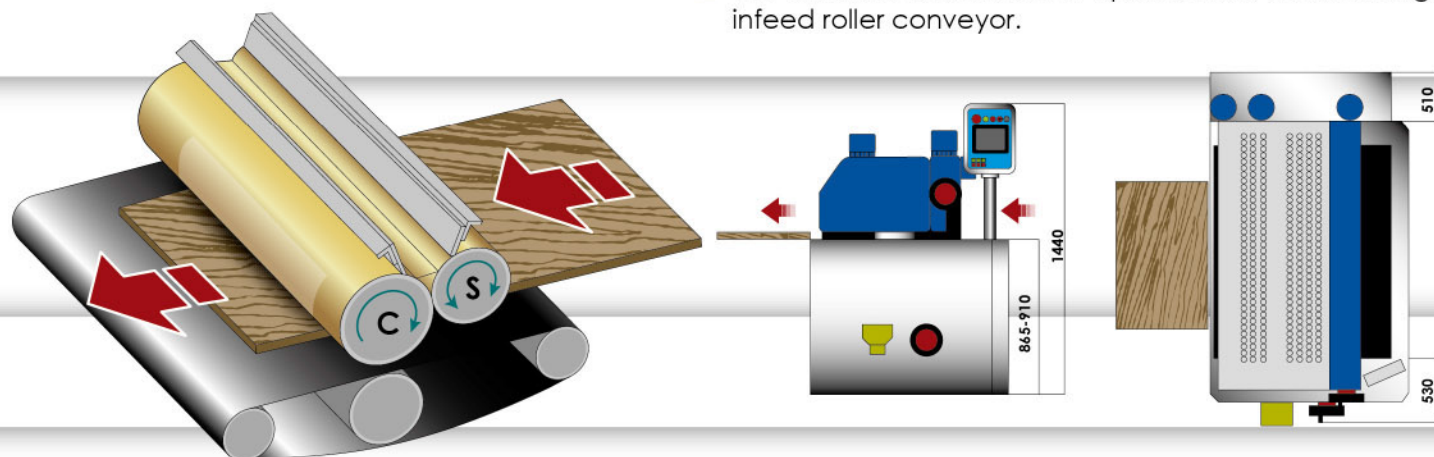

滾筒式平面塗裝機 ROLLER COATER

- YL-W2T -T
- YL-W3T -T
- YL-W4T -T

特性

- 本機適用於平面塗裝。經本機處理過的工件，表面光滑、無色差。
- 每個滾輪應用獨立的變頻器做電子控制，產品品質可利用均佈滾筒的速度及壓力做調整可將漆完美的塗在工件上。
- 獨家鳩尾槽支撐系統的應用頭。
- 利用具有自動皮帶定位系統的皮帶輪運送工件。
- 清潔刀片具有外部的靠近及分離控制（不必升起保護柵欄）。
- 具有快速更換滾輪系統。
- 氣動雙隔膜泵浦，不產生火花，安全更不會有空氣污染之慮。
- 電動升降裝置與限動開關保護膠輪超厚斷電停止。
- 此機器可與加長型輸送機共用。

FEATURES

- This machine is applied for flat coating, providing workpieces of smooth finishing and consistent color.
- Each roller is independently controlled by a frequency inverter. The smoothing roller speed and pressure are adjustable, ensuring perfect coating on workpiece.
- The application head is supported by the exclusively designed dovetailed support system.
- Workpiece is fed through a conveyor belt that features automatic positioning.
- Cleaning scrapers can be conveniently controlled from outside without need to raise the grid guard.
- Rollers are easy to replace.
- Double air diaphragm pump does not create sparks, while ensuring operational safety and is air-pollution-free.
- The powered elevation design combined with limit switch provides over-travel protection. In case over-travel occurs, power shuts off automatically.
- The machine is available to operate with an extra large infeed roller conveyor.

適用 本機可另外可做著色機使用。

以UV底、UV面、PU、NC、水性塗料塗裝地板/傢俱/木片/玻璃/壁板/地磚/合板...等平面塗裝之使用。

APPLICATIONS The machine is also suitable for staining.

Flat coating with UV base / surface, PU, NC and water-based lacquer for floor / furniture / wood slice / glass / wall plane / tile / plywood and so on.

SPECIFICATIONS

型號	Model	YL-W2T-T	YL-W3T-T	YL-W4T-T	YL-W5T-T
最大塗裝寬度	Maximum width of coating	610 mm	920 mm	1290 mm	1650 mm
最短塗裝長度	Minimum length of coating	300 mm	300 mm	300 mm	300 mm
工件厚度	Workpiece thickness range	2-80 mm	2-80 mm	2-80 mm	2-80 mm
輸送帶速度	Conveyor belt speed	10-20M/min 其它速度可依客戶指定 Other speeds are available			
◎ 塗佈輪尺寸(mm)	Coating roller sizes (mm)	Ø205x780	Ø250x1100	Ø250x1450	Ø250x1800
◎ 均佈輪尺寸(mm)	Smoothing roller sizes (mm)	Ø150x780	Ø175x1100	Ø175x1450	Ø175x1800
◎ 塗佈輪馬力	Coating roller motor	0.75 KW	1.5 KW	1.5 KW	1.5 KW
◎ 均佈輪馬力	Smoothing roller motor	0.18 KW	0.37 KW	0.37 KW	0.75 KW
輸送帶馬力	Conveyor belt motor	0.75 KW	1.5 KW	1.5 KW	1.5 KW
昇降馬力	Elevation motor	0.18 KW	0.18 KW	0.18 KW	0.37 KW
泵浦(氣壓式隔膜泵浦)	Pump (air diaphragm pump)	1 / 2"	1 / 2"	1 / 2"	3 / 4"

規格、尺寸、外型及顏色若有變更恕不另通知。 Specifications, dimensions, appearance and color are subject to change without prior notice.
可依客戶需求定製特殊規格。 Customization is available to meet special process requirements.

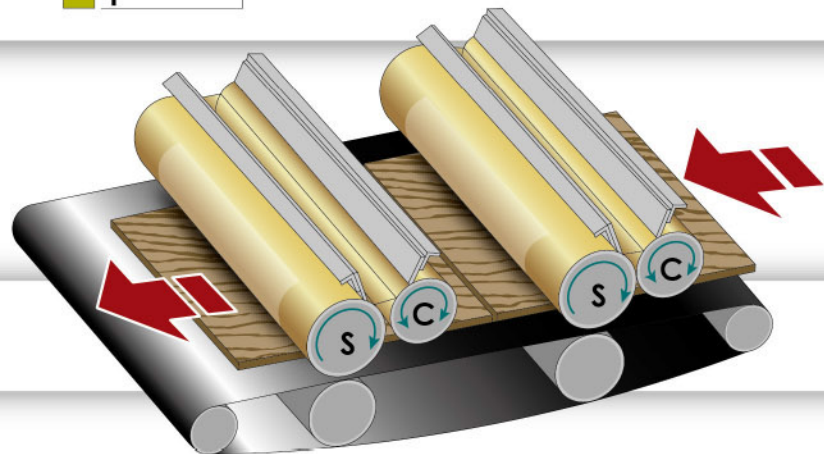
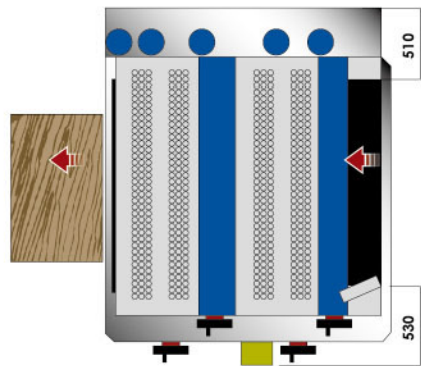
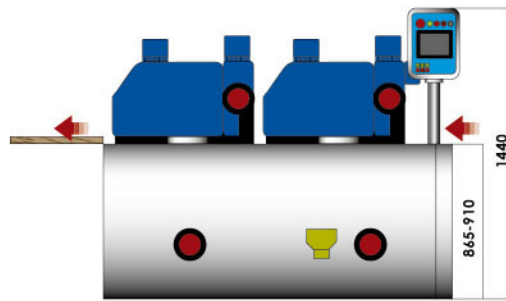

底漆填補機 FILLER REPLENISHER

- YL- W2TA -M
- YL- W3TA -M
- YL- W4TA -M

適用

UV底、塗料塗裝、地板、傢具、木片、壁板、合板...等平面塗裝之使用。

APPLICATIONS

UV lacquered, floor, furniture, wood slice, wall plane, plywood and so on for flat coating use.

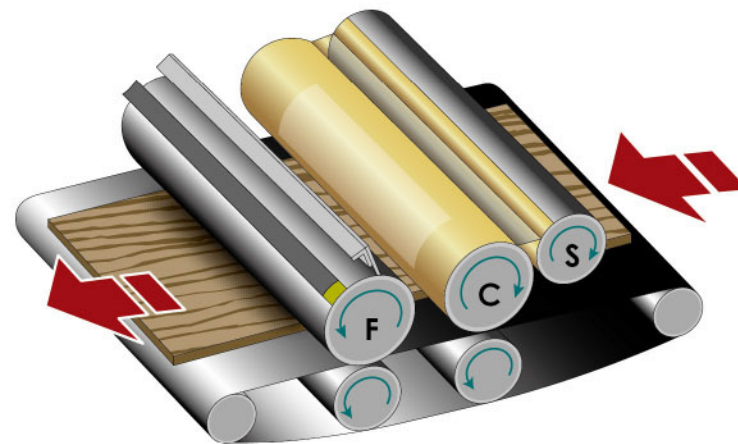
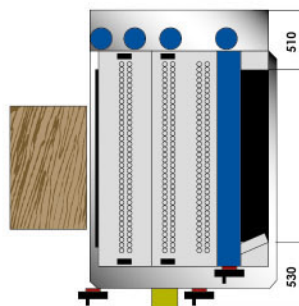
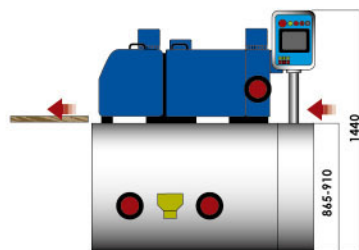

特性

- 有關塗裝工件紋路粗糙，甚至出現小針孔現象均可填平而呈現細緻表面。
- 本機適UV等之塗裝工作經逆轉後，可將表面多餘塗料刮除，再循環使用，不浪費。
- 每個滾輪應用獨立的變頻器做電子控制，產品品質可利用填補輪的速度及壓力做調整可將漆完美的塗在工件上。
- 獨家鳩尾槽支撐系統的應用頭。
- 利用具有自動皮帶定位系統的皮帶輪運送工件。
- 清潔刀片具有外部的靠近及分離控制（不必升起保護柵欄）。
- 均佈輪可調整工作與上油漆的厚度而維持工作的標準品質。
- 電動升降裝置與限動開關保護膠輪超厚斷電停止。
- 此機器可與加長型輸送機共用。

FEATURES

- All defects such as coarse grain and pores can be filled up to achieve extremely fine finish surface.
- The machine is suitable for UV paint coating. With the counter-clockwise running of roller, the paint surplus on the workpiece can be removed for reuse without waste of paint.
- Each roller is independently controlled by a frequency inverter. The filler roller speed and pressure are adjustable, ensuring perfect coating on workpiece.
- The application head is supported by the exclusively designed dovetailed support system.
- Workpiece is fed through a conveyor belt that features automatic positioning.
- Cleaning scrapers can be conveniently controlled for approaching and separation from outside without need to raise the grid-guard.
- Coating thickness is adjusted by means of smoothing roller that ensures high coating quality.
- The powered elevation design combined with limit switch provide over-travel protection. In case over-travel occurs, power shuts off automatically.
- The machine is available to operate with an extra long infeed roller conveyor.

SPECIFICATIONS

型號	Model	YL-W2TA-M	YL-W3TA-M	YL-W4TA-M	YL-W5TA-M
最大塗裝寬度	Maximum width of coating	610 mm	920 mm	1290 mm	1650 mm
最短塗裝長度	Minimum length of coating	300 mm	300 mm	300 mm	300 mm
工件厚度	Workpiece thickness range	2-80 mm	2-80 mm	2-80 mm	2-80 mm
輸送帶速度	Conveyor belt speed	10-20M/min		其它速度可依客戶指定 Other speeds are available	
● 塗佈輪尺寸(mm)	Coating roller sizes (mm)	Ø205x780	Ø250x1100	Ø250x1450	Ø250x1800
● 均佈輪尺寸(mm)	Smoothing roller sizes (mm)	Ø150x780	Ø175x1100	Ø175x1450	Ø175x1800
● 填補輪尺寸(mm)	Filler roller sizes (mm)	Ø200x780	Ø250x1100	Ø250x1450	Ø250x1800
● 塗佈輪馬力	Coating roller motor	0.75 KW	1.5 KW	1.5 KW	1.5 KW
● 均佈輪馬力	Smoothing roller motor	0.18 KW	0.37 KW	0.37 KW	0.75 KW
● 填補輪馬力	Filler roller motor	0.18 KW	0.75 KW	0.75 KW	1.5 KW
● 輸送帶馬力	Conveyor belt motor	0.75 KW	1.5 KW	1.5 KW	1.5 KW
● 昇降馬力	Elevation motor	0.18 KW	0.18 KW	0.18 KW	0.37 KW
● 泵浦(氣壓式隔膜泵浦)	Pump (air diaphragm pump)	3 / 4"	3 / 4"	3 / 4"	3 / 4"

規格、尺寸、外型及顏色若有變更恕不另通知。 Specifications, dimensions, appearance and color are subject to change without prior notice.
可依客戶需求定製特殊規格。 Customization is available to meet special process requirements.

滾筒式平面塗裝機 ROLLER COATER

- YL-W2TA-T
- YL-W3TA-T
- YL-W4TA-T

特性

- 本機適用於平面塗裝。經本機處理過的工件，表面光滑、無色差。
- 每個滾輪應用獨立的變頻器做電子控制，產品品質可利用均佈滾筒的速度及壓力做調整可將漆完美的塗在工件上。
- 獨家鳩尾槽支撐系統的應用頭。
- 利用具有自動皮帶定位系統的皮帶輪運送工作件。
- 清潔刀片具有外部的靠近及分離控制（不必升起保護柵欄）。
- 具有快速更換滾輪系統。
- 氣動雙隔膜泵浦，不產生火花，安全更不會有空氣污染之慮。
- 電動升降裝置與限動開關保護膠輪超厚斷電停止。
- 此機器可與加長型輸送機共用。

FEATURES

- This machine is applied for flat coating, providing workpieces of smooth finishing and consistent color.
- Each roller is independently controlled by a frequency inverter. The smoothing roller speed and pressure are adjustable, ensuring perfect coating on workpiece.
- The application head is supported by the exclusively designed dovetailed support system.
- Workpiece is fed through a conveyor belt that features automatic positioning.
- Cleaning scrapers can be conveniently controlled from outside without need to raise the grid guard.
- Rollers are easy to replace.
- Double air diaphragm pump does not create sparks, while ensuring operational safety and is air-pollution-free.
- The powered elevation design combined with limit switch provides over-travel protection. In case over-travel occurs, power shuts off automatically.
- The machine is available to operate with an extra large infeed roller conveyor.

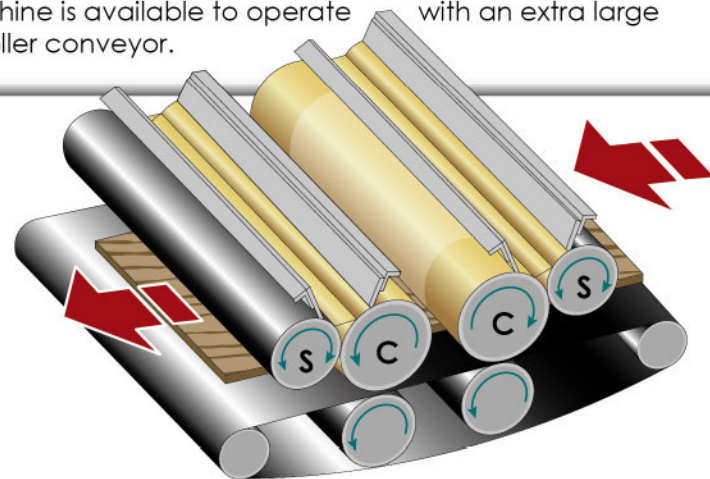
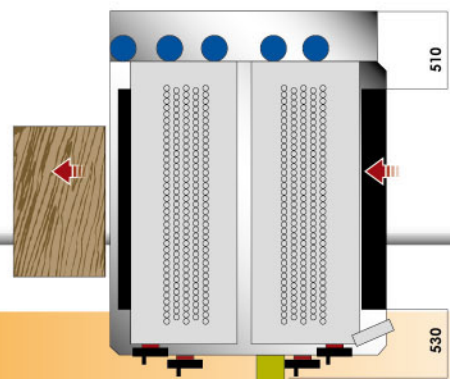
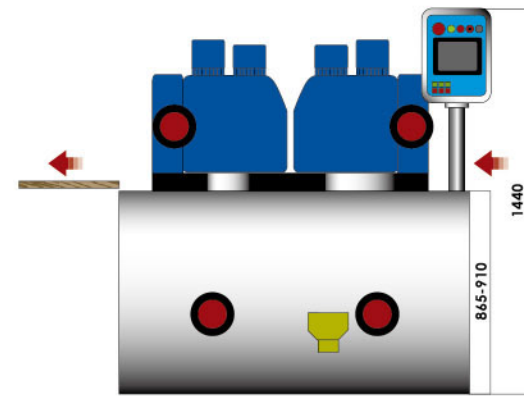

適用

以UV底、UV面塗料塗裝地板/傢俱/木片/玻璃/壁板/地磚/合板...等平面塗裝之使用。

APPLICATIONS

Flat coating with UV base / surface lacquer for floor / furniture / wood slice / glass / wall plane / tile / plywood and so on.



SPECIFICATIONS

型號	Model	YL-W2TA-T	YL-W3TA-T	YL-W4TA-T	YL-W5TA-T
最大塗裝寬度	Maximum width of coating	610 mm	920 mm	1290 mm	1650 mm
最短塗裝長度	Minimum length of coating	300 mm	300 mm	300 mm	300 mm
工件厚度	Workpiece thickness range	2-80 mm	2-80 mm	2-80 mm	2-80 mm
輸送帶速度	Conveyor belt speed	10-20M/min	其它速度可依客戶指定 Other speeds are available		
◎ 塗佈輪尺寸(mm)	Coating roller sizes (mm)	Ø205x780	Ø250x1100	Ø250x1450	Ø250x1800
◎ 均佈輪尺寸(mm)	Smoothing roller sizes (mm)	Ø150x780	Ø175x1100	Ø175x1450	Ø175x1800
◎ 塗佈輪馬力	Coating roller motor	0.75 KW	1.5 KW	1.5 KW	1.5 KW
◎ 均佈輪馬力	Smoothing roller motor	0.18 KW	0.37 KW	0.37 KW	0.75 KW
輸送帶馬力	Conveyor belt motor	0.75 KW	1.5 KW	1.5 KW	1.5 KW
昇降馬力	Elevation motor	0.18 KW	0.18 KW	0.18 KW	0.37 KW
泵浦(氣壓式隔膜泵浦)	Pump (air diaphragm pump)	1 / 2"	1 / 2"	1 / 2"	3 / 4"

規格、尺寸、外型及顏色若有變更恕不另通知。 Specifications, dimensions, appearance and color are subject to change without prior notice. 可依客戶需求定製特殊規格。 Customization is available to meet special process requirements.

淋幕式平面塗裝機 CURTAIN COATER

- YL- 10F
- YL- 20F
- YL- 30F
- YL- 40F

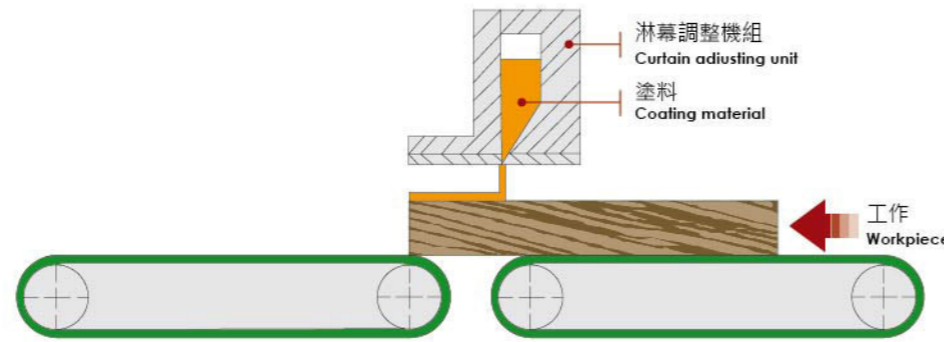

特性

- 本機乃UV、P U、NC、水性塗料塗裝之專用機種及組合式傢俱、木製玩具、拼圖等之平面塗裝機種。
- 淋幕塗料之間隙可由手輪兩端同步調整，亦可由計數器數字顯示其間隙大小，淋膜分佈均勻，節省塗料。
- 採用強力塗料輸送泵，運轉無聲，塗料流量可任意調整，並可消除塗料因溫升而變質。未使用完了的塗料經回收槽流回塗料桶內，再循環使用，不浪費。
- 輸送帶採用高級合成樹脂製成，不易斷裂，塗料沾污表面容易消除。
- 另本機之塗料桶設有加熱器，遇塗料溫度過低時，可予加熱，以供作業。

FEATURES

- The machine is applicable for UV, PU, NC and water-based lacquer paint. Suitable for surface coating for various K/D furniture, wooden toys and composite figures, etc.
- The gap for paint can be synchronously adjusted at both ends. The gap is indicated by a counter. With this accurate adjustment, you get uniform distribution of coating and paint saving.
- Powerful paint delivery pump features quiet running and adjustable paint flow rate. No paint deterioration due to temperature growth. Paint surplus is delivered to a collection tank for return-flow to the paint tank, which can be reused without waste.
- The conveyor belt is manufactured from high quality synthetic resin, featuring no breakage, and it is easy to clean off the paint pollution.
- The paint tank is equipped with a heater. Incase paint temperature is too low, it can be heated to ensure normal operation.

SPECIFICATIONS

型號 Model number	有效塗裝寬度 Effective coating width	工件厚度 Workpiece thickness	工件最短塗裝長度 Min. workpiece coating length	塗料輸送泵動力 Transfer pump power	輸送動力 Feeding power
YL-10F	300mm	1-35mm	300mm	1HP	1HP
YL-20F	610mm		300mm	1HP	1HP
YL-30F	920mm		350mm	2HP	1HP
YL-40F	1290mm		350mm	2HP	2HP

規格、尺寸、外型及顏色若有變更恕不另通知。 Specifications, dimensions, appearance and color are subject to change without prior notice.
可依客戶需求定製特殊規格。 Customization is available to meet special process requirements.

背面滾塗機+UV乾燥機 ROLLER COATER (BACK TYPE) + UV CURING MACHINE

YL-201B + 201W

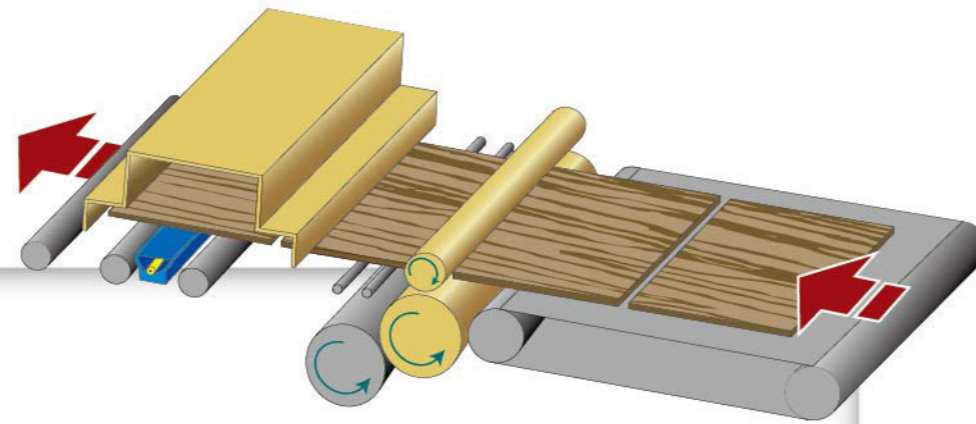

NEW model



特性

- 本機適用於背面滾塗平面塗裝作業。
- 氣動式雙隔膜泵浦，不產生火花，安全，更不會有空氣污染之慮。
- 輸送帶可調整其速度範圍10~20 M/min。
- 操作簡單，僅需將工作件放置於輸送帶上即可，不需技術人員操作。

FEATURES

- The roller coater is designed for coating backside of workpiece.
- Air operated dual diaphragm pump features no sparking, is safe, and has no air pollution problem.
- Conveyor belt speed is adjustable in the range of 10~20 M/min.
- Easy to operate. The operator only needs to place workpieces on the conveyor belt without the need of an experienced technician.

SPECIFICATIONS

型號	Model	YL-201B+201W	YL-301B+301W	YL-401B+401W
最大塗裝寬度	Maximum width of coating	610 mm	920 mm	1290 mm
最短塗裝長度	Minimum length of coating	300 mm	300 mm	300 mm
工件厚度	Workpiece thickness range	2-50 mm	2-50 mm	2-50 mm
輸送帶速度	Conveyor belt speed	10-20M/min	其它速度可依客戶指定 Other speeds are available	
塗佈輪尺寸(mm)	Coating roller sizes (mm)	Ø152x620	Ø152x930	Ø180x1300
均佈輪尺寸(mm)	Smoothing roller sizes (mm)	Ø100x620	Ø100x930	Ø125x1300
輸送帶馬力	Conveyor belt motor	0.75 KW	0.75 KW	0.75 KW
泵浦(氣壓式隔膜泵浦)	Pump (air diaphragm pump)	3 / 8"	3 / 8"	3 / 4"

規格、尺寸、外型及顏色若有變更恕不另通知。 Specifications, dimensions, appearance and color are subject to change without prior notice.
可依客戶需求定製特殊規格。 Customization is available to meet special process requirements.

周邊設備

PERIPHERAL EQUIPMENT

配件 ACCESSORIES

PERIPHERAL EQUIPMENT

ACCESSORIES

YL- W2-2C / YL- W3-3C / YL- W4-4C



輸送機

用於砂光機、滾輪塗佈機的板材送料

CONVEYOR

Suitable for panel feeding for sander and roller coater.

YL- W2T-DR /
YL- W3T-DR / YL- W4T-DR

板面粉塵清除機

PANEL SURFACE DUST
REMOVING MACHINE



YL-W2-MF /
YL-W3-MF / YL-W4-MF

自動送料機

AUTOMATIC FEEDER

YL- W2T-W / YL- W3T-W / YL- W4T-W

UV乾燥機

- 瞬間乾燥，可立即進行後續作業，節省作業時間。
- 連線作業，塗裝後成品直接乾燥，免除搬運之苦，減少存放空間，提高生產效率。
- 乾燥後，塗裝物表面硬度提高，光潔亮麗。
- 適用範圍廣，涵蓋平面或立體的工作，如木器類、傢俱類、建材類。

UV CURING MACHINE

- Instant drying permits immediate consecutive processing for saving considerable time.
- Suitable for online operation. After coating, workpieces can be directly dried. The benefits are eliminating workpiece handling time, reducing workpiece storing space and increasing production efficiency.
- After drying, the product surface hardness will increase and features extra fine finish.
- Wide application range including plane or 3D workpiece, such as wood products, furniture and construction materials, etc.



YL-W2T-HC /
YL-W3T-HC / YL-W4T-HC

加熱平坦輸送機(紅外線乾燥機)

本機乃烘烤經塗裝後的工作，將表面之塗料氣泡平展消除，使其表面美觀，便於後續作業。

輸送速度無段變速調整，可針對工件之特性，調整其速度。

HEATING FLATTENING MACHINE
(INFRARED RAY DESICCATOR)

This machine is designed for baking the coated workpiece to remove the bubbles on the coating surface. This results in an excellent surface for consecutive processing. Variable feed speed allows speed change as desired to suit workpiece characteristics.



標準配備 STANDARD ACCESSORIES



手動進退調整輪
Manual forward/
backward
control handwheel



控制箱系統
Control system



數字型控制面板
Digital control panel



減速機昇降裝置
Elevation driven by
speed reducer

選購配備 OPTIONAL ACCESSORIES



機械滑動輪
Machine movable wheel



塗料加溫桶
Paint heating tank

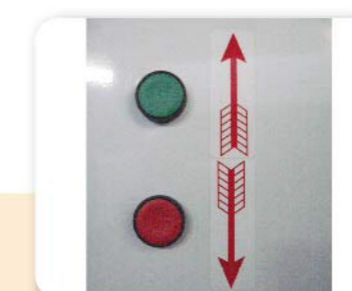

自動昇降調整裝置
Automatic elevation
adjustment device



微電腦控制面板
Micro-computer
control panel



氣動攪拌機
Air agitator

超耐磨木地板塗裝流程 / UV 滾塗流程

CONATING FLOW LINE FOR SUPER WEAR-RESISANT WOODEN PARQUET / UV ROLLING COATING FLOW LINE

CONATING FLOW LINE FOR SUPER WEAR-RESISANT WOODEN PARQUET / UV ROLLING COATING FLOW LINE

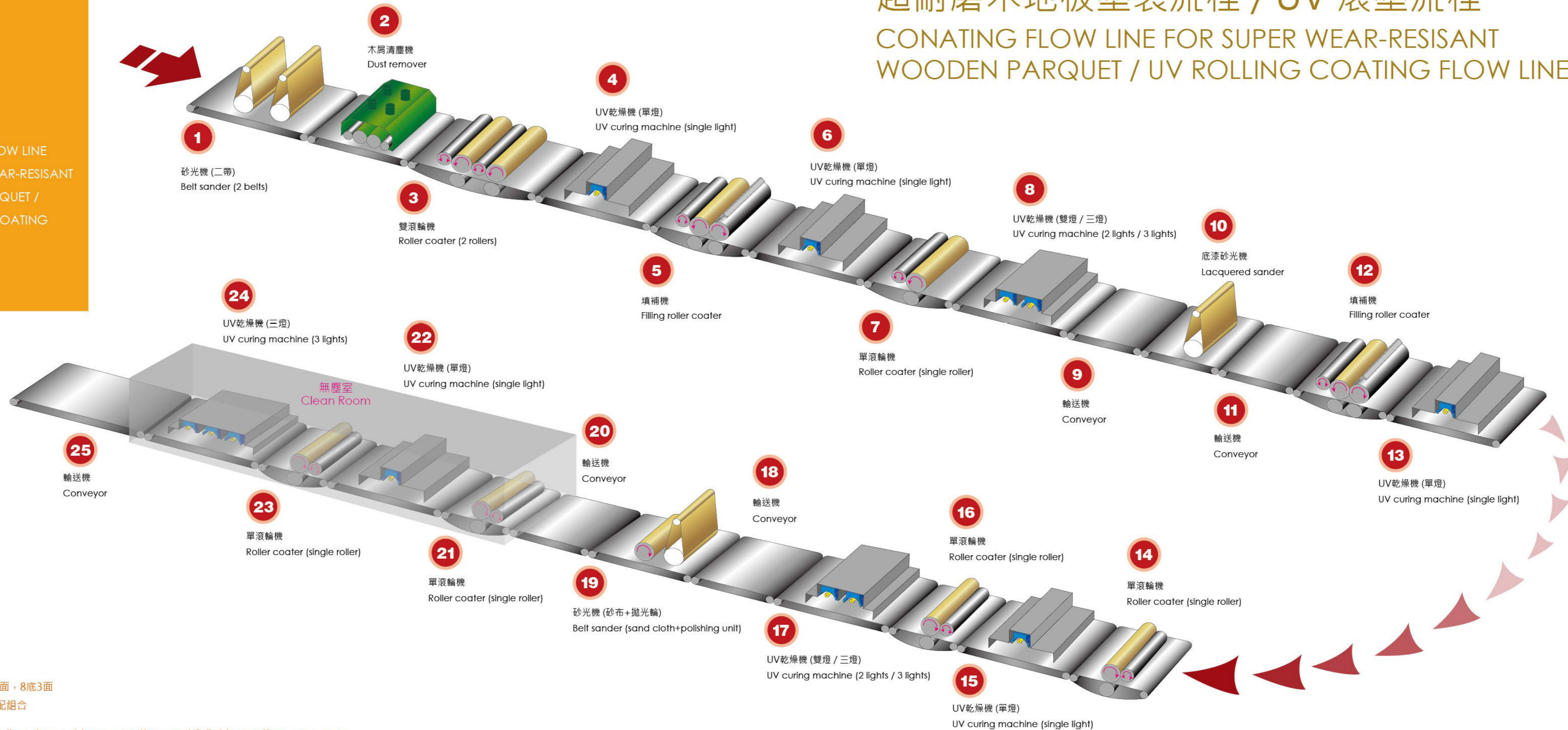

- 此為6底2面
- 可排6底3面或8底2面，8底3面
- 可依客戶的需求搭配組合

- This production line shows 6 base coating and 2 finish coating processes.
- Other coating processes such as 6 base coating with 3 finish coating, 8 base coating with 2 finish coating and 8 base coating with 3 finish coating are available.
- Coating processes can be specified as desired.